

ARBO

Sealants for the professional

ARBO® SEALANTS AND ARBO® FACADE SOLUTIONS
PRODUCT CATALOGUE



Contents

Product Portfolio	4
<hr/>	
ARBO® FAÇADE SOLUTIONS	6
ARBO EPDM MEMBRANE SYSTEM	9
ARBO XPANDA 600 EXPANDING FOAM TAPE	11
<hr/>	
ARBO® SEALANTS	12
Projects	27



"We have been developing products and sealants for the professional user at our UK manufacturing base for nearly 160 years, and are proud of our traditional values. We continue to work with a variety of customers to produce solutions to individual requirements and projects, offering a unique flexibility of approach that delivers sealant solutions that work in the modern environment"



Over 150 Years of Excellence.

Adshead Ratcliffe & Co Ltd was founded in 1859 and is proud of its long-established British manufacturing base.

Our mission is to develop and offer to customers a quality range of products backed up by high levels of service – both via sales representatives in the field and the Production and Administrative Teams in our HQ and Distribution Centres.

Based in Belper, Derbyshire, we are recognised as one of the most successful and growing business in the region. We have a philosophy of innovation, and have our in-house Research and Development facilities with our laboratory, alongside extensive manufacturing and training facilities, that make the Company well positioned to respond to customer needs and market requirements. Our products are manufactured to quality standards recognised within the UK and globally.

We are regarded as the premier manufacturer of sealants, and our products are sold under the leading ARBO® Brand containing a range of sealants for the professional user, together with the extensive range of EPDM products marketed under the ARBO® Façade Solutions brand. We continue to invest in our people and products, and are committed to supplying quality products manufactured to exacting standards, to our many customers nationally and internationally.

In early 2017, Adshead Ratcliffe & Co became part of CARLISLE® CM Europe following the acquisition by the US group CARLISLE® Companies Incorporated. The CARLISLE® CM Europe group is Europe's leading waterproofing and sealing solutions provider for roofs, façades, and buildings. The umbrella brand CARLISLE® CM Europe unites the trusted brands ARBO® RESITRIX®, HERTALAN®, ALUTRIX®, HARDCAST® and ECOLAN®

Our ARBO® brand sealants are respected throughout the building, glazing and construction industries by architects specifiers and contractors, and with specialist products available for marine, automotive and industrial sectors our customer base is wide.

As a dedicated sealant manufacturer we are able to supply products to meet virtually any requirement and our in-house research and development facilities are able to tailor-make sealants for more specialised applications and for colour matching to order.

COMMITMENT TO QUALITY

Our ongoing commitment to quality is reflected in our ISO 9001:2015 and ISO 14001:2015 certifications, together with our work with BSI to ensure standards are maintained. Working closely with a wide range of specifiers such as Architects, Surveyors and Local Authorities, we follow projects from the early stages of design right through to completion with Sealants Applicators, then if required as part of the Arbomaster Warranty Scheme, we carry out on site inspections of applied sealants.



Service

CUSTOMER SERVICE

DIRECT TELEPHONE LINE:

01773 826661

Our friendly staff are committed to giving you the highest levels of service and most products are available ex-stock.

Next day deliveries can be arranged in conjunction with our logistics partners, with normal delivery within 48 hours.

TECHNICAL SUPPORT

DIRECT TELEPHONE LINE:

01773 596301

Technical queries and written specifications are available through our technical support line, with our highly trained and experienced staff able to answer any questions.

Our testing facilities are also available to assess the suitability of sealants against specific substrates to ensure compatibility and performance.

Striving to better meet industry needs, our website www.arbo.co.uk provides desktop advice for architects and specifiers, assisting sealant selection. Detailed technical data sheets are also available on our website at: www.arbo.co.uk

SALES SUPPORT

Our field sales team covers the entire UK and is pleased to visit and advise customers on the selection and availability of our products – this includes site visits and tool box talks when appropriate.

CONTINUOUS IMPROVEMENT

The culture of our company is one of continuous improvement and the specification of our products will evolve in response to technological advances, research and development and environmental factors.

DISTRIBUTION CENTRES

BELPER

Derby Road, Belper, Derbyshire, England, DE56 1WJ

T 01773 826661
F 01773 821215
E arbo@arbo.co.uk

Opening Hours

Mon to Fri
07.00 to 16.30

MANCHESTER

Unit 54, Oakhill Trading Estate, Worsley Road North, Worsley, Manchester, M28 3PT.

T 01204 795335
F 01204 862795
E manc@arbo.co.uk

Opening Hours

Mon to Thu
07.00 to 16.30
Fri
07.00 to 16.00

ESSEX

Unit P1, Pegasus Works, Hainault Business Park, Roebuck Road, Hainault IG6 3UF

T 020 8501 5005
F 020 8500 9830
E woodford@arbo.co.uk

Opening Hours

Mon to Thu
06.00 to 15.30
Fri
06.00 to 14.30

LONDON

Unit 22, Old Jamaica Business Estate, 24 Old Jamaica Road, London, SE16 4AW.

T 0207 3945065
F 0207 3945067
E SE16@arbo.co.uk

Opening Hours

Mon to Thu
06.30 to 16.00
Fri
06.30 to 14.00

ARBO

FAÇADE SOLUTIONS

ARBO® Façade Solutions have developed their own EPDM system to seal internally between window frames and a variety of substrates with high quality EPDM utilising solvent free adhesives. This green system helps the building achieve Document L.

This important detail can no longer be ignored. Responsible fabricators and installers are being asked by main contractors 'to seal that gap'.

Legislation is going to get tougher in the future, and your clients will be expecting you to provide a robust solution at this detail for certification of the building. We can help by specifying and carrying out site visits to ensure successful completion of contract.

Arbo Façade Solutions EPDM System provides the following key advantages:

- It is clean, green and easy to apply
- Easy factory or site application
- No fumes
- No smell

For further information and quotes contact Arbo Façade Solutions on **01773 826661** or email: arbo@arbo.co.uk

ARBO® EPDM MEMBRANE SYSTEM

TO REDUCE HEAT AND AIR LEAKAGE FROM A BUILDING

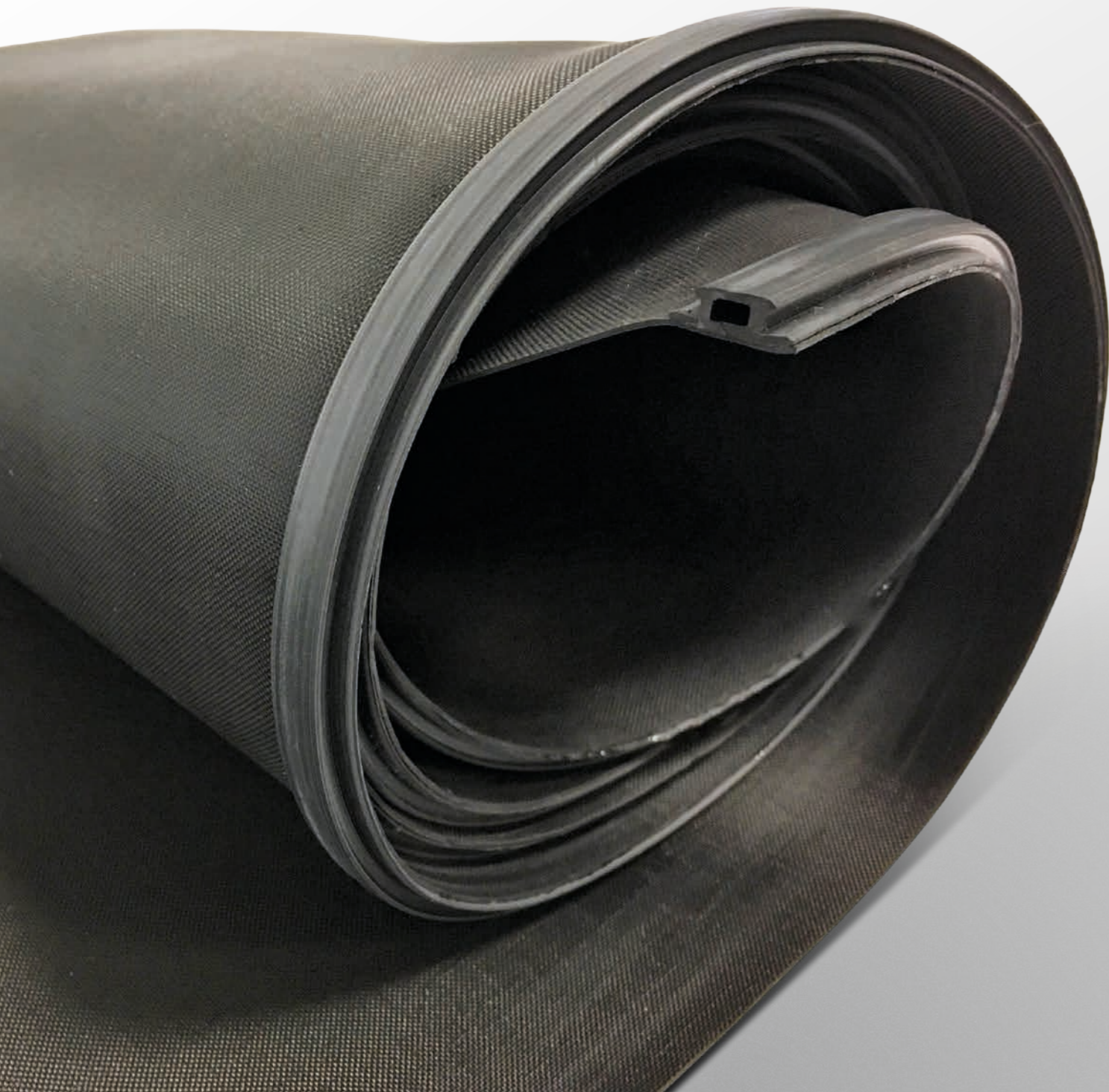

ARBO® EPDM MEMBRANE SYSTEM

Following the introduction of Document L, it has become a requirement to provide a robust seal to the internal interfaces between different façade components of a construction. The purpose of this seal is to reduce heat and air leakage from a building and to help prevent interstitial condensation. To aid rapid construction techniques, contractors demand that a building is made substantially waterproof as early as possible during construction. The use of the ARBO® EPDM system plays an important role in achieving this aim.

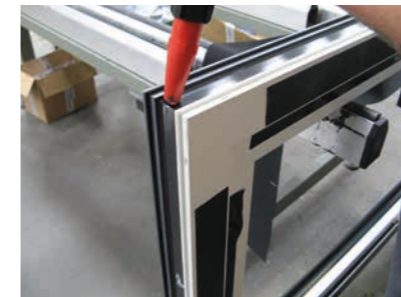

EPDM MEMBRANE AVAILABLE IN SIZES FROM 100 mm TO 1.4 METRE WIDE (IN 50 mm INCREMENTS)

ARBO® BUTE AL-BAND 50 mm, 75 mm, 100 mm
10 m ROLL WIDTHS

ARBO® SA ADHESIVE 600 ml Foils

ARBO® MEMBRANE ADHESIVE 600 ml Foils

EPDM ROLLER 100 mm wide

EPDM ROLLER 150 mm wide

HAND BARREL FOIL GUN

ARBO® 2650 PRIMER 500 ml tin

AFS PRIMER 1 Ltr tin

ARBO® TERMINATOR STRIP 25 x 3 metre pack
18 mm x 3 mm

ARBO® INSTANT EPDM 100 mm - 1 m wide

ARBO® PROFILED EPDM 100 - 300 mm wide

ARBO® BUTYL STRIP EPDM 100 - 300 mm wide

ARBO® CONTACT ADHESIVE 4.2 kg tin

Allow one 600 ml foil 8-10 metres of epdm for widths up to 150 mm
Thickness of Membrane 0.75 mm
Length of Roll 25 metres
EPDM is also available in 1 mm and 2 mm thickness

For further information and quotes contact Arbo Façade Solutions on 01773 826661 or email: arbo@arbo.co.uk

ALL PHOTO'S COURTESY OF APIC UK LTD



ARBO® XPANDA 600 EXPANDING FOAM TAPE

EXPANDING JOINT SEALING TAPE

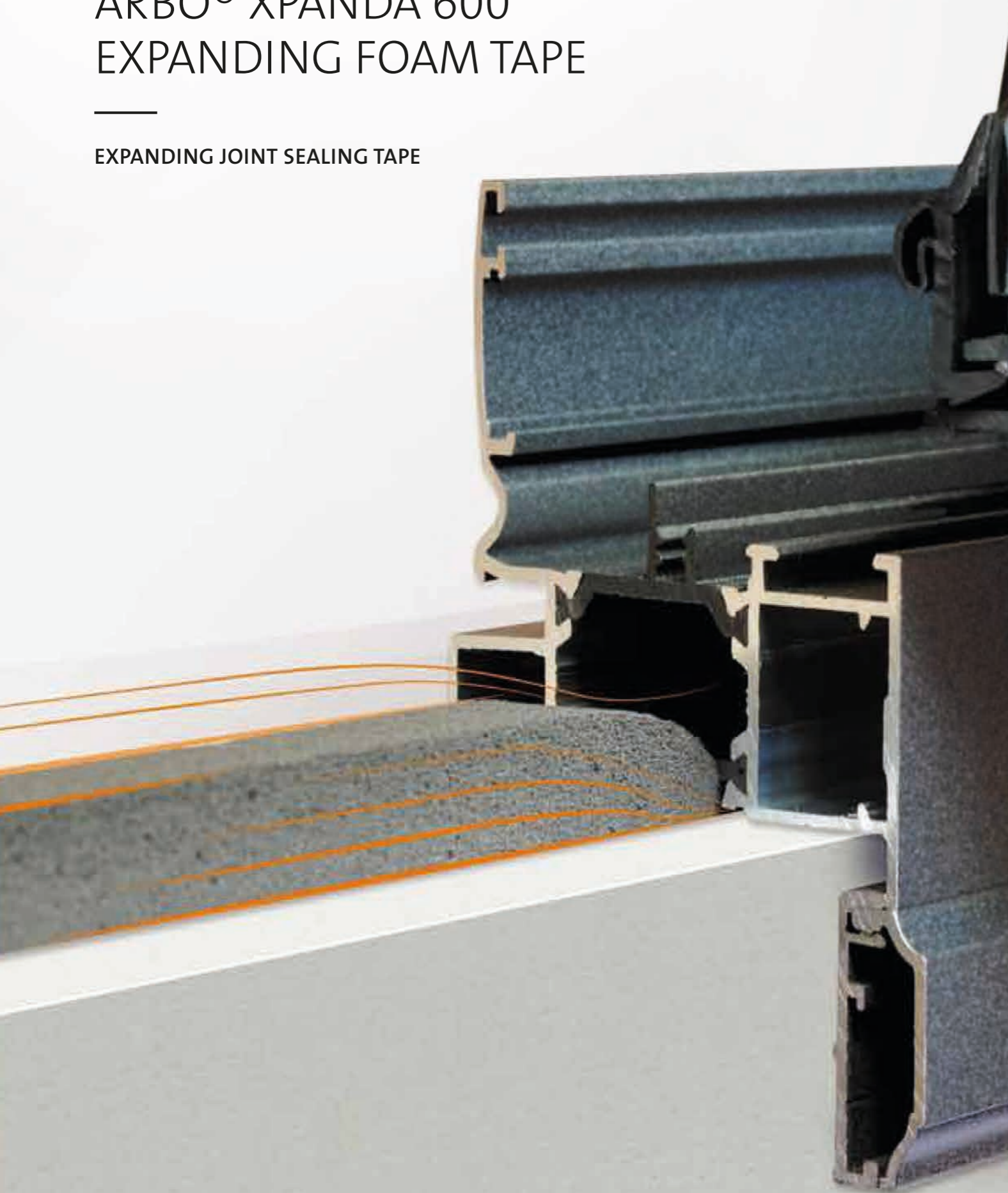

ARBO® XPANDA 600 expanding foam tape

ARBO® XPANDA 600 is an expanding foam tape (with a unique combination of a resilient foam and a water resisting binder), which combine to produce a “dry” pre-formed strip seal used to resist weather ingress in fenestration, roofing and construction applications. The result is a weather resistant sealant for water/air tightness, thermal insulation and noise control.

PRODUCT SPECIFIC PROPERTIES:

- Expanding joint sealing tape
- Resilient foam with water resisting binder
- Preformed strip seal to resist weather ingress in fenestration, roofing and construction applications
- BBA Approved
- Noise and vibration damping
- Easy installation
- At 10 % compression – Soundproofing and anti vibration
- At a minimum of 50 % compression – Thermal insulation and dust particle insulation
- At 75 % compression – Water resistance (after 75 % compression the performance of the joint improves)

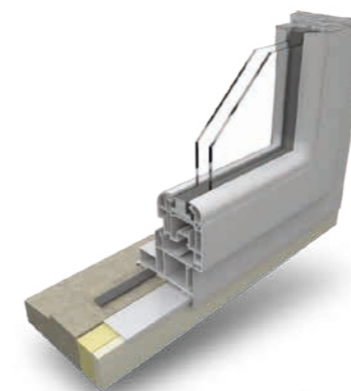
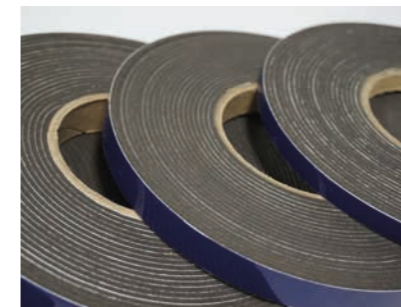

GAP SIZE mm	COIL WIDTH mm	EXP THICKNESS mm	COILS/BOX	METRES/COIL	ORDER REF:
1.5 - 3	10	9	48	12.50	FCVITA1009
2 - 4	10	13	48	10.00	FCVITA1014
2 - 4	15	13	32	10.00	FCVITA1514
3 - 7	10	17	48	8.00	FCVITA1017
3 - 7	15	17	32	8.00	FCVITA1517
3 - 7	20	17	24	8.00	FCVITA2017
3 - 7	25	17	20	8.00	FCVITA2517
5 - 10	15	26	32	5.60	FCVITA1526
5 - 10	20	26	24	5.60	FCVITA2026
5 - 10	25	26	20	5.60	FCVITA2526
7 - 12	15	33	32	4.30	FCVITA1533
7 - 12	20	33	24	4.30	FCVITA2033
8 - 15	20	44	24	3.30	FCVITA2044
8 - 15	30	44	16	3.30	FCVITA3044
10 - 18	20	53	24	3.00	FCVITA2053
10 - 18	25	53	20	3.00	FCVITA2553
10 - 18	30	53	16	3.00	FCVITA3053
13 - 24	20	72	24	2.00	FCVITA2072
13 - 24	25	72	20	2.00	FCVITA2572
13 - 24	30	72	16	2.00	FCVITA3072
13 - 24	40	72	12	2.00	FCVITA4072
24 - 40	40	123	12	2.00	FCVITA40123

ARBO

SEALANTS

As a dedicated sealant manufacturer we are able to supply products to meet virtually any requirement and our in-house research and development facilities are able to tailor-make sealants for more specialized applications and for colour matching to order.



Glazing and bedding compounds

PRODUCT	CODE	COLOUR	SIZE
	ARBOFLEX 500	Butyl Glazing Compound	
		Applications	
		• Glazing of insulating glass units into timber frames in conjunction with Arbosil LM or Arbosil 1096, in accordance with NHBC, GGF & BS 8000 recommendations	
	ARBOLITE PUTTY	For Wood and Metal Frames	
		GCLIT02BGR Grey 2 kg Bucket 6 per box	
		GCLIT05BGR Grey 5 kg Bucket single	
	ARBO LINSEED OIL PUTTY	For Wood Frames	
		Manufactured to BS544	
		GCLOP02BNT Natural 2 kg Bucket 6 per box	
	ARBO UBC	Butyl Bedding Compound	
		Applications	
		• Bedding of window frames into timber, brickwork or concrete openings	
	ARBO SOFTENING MEDIUM	Arbo Softening Medium	
		PRSM05T	500 ml Tin single
	ARBO POLYMER PUTTY	Acrylic Polymer Putty	
		Applications	
	ARBO MIRROR ADHESIVE	One-part high modulus modified polymer sealant	
		Applications	







Acrylic Sealants

PRODUCT	APPLICATIONS	CODE	COLOUR	SIZE
	ARBOCAULK	Internal caulking and pointing	ACCLK40CWH White	380 ml Cartridge 25 per box
		Emulsion Acrylic Sealant to ISO11600 F 7.5P		
	PDC	Painters & Decorators Caulk	ACCLK30CWH White	310 ml Cartridge 25 per box



Silicone Sealants

PRODUCT	APPLICATIONS	CODE	COLOUR	SIZE
	ARBOSIL LM	• Perimeter pointing	SLLM30CBL Black	310 ml Cartridge 25 per box
		• PVCu windows	SLLM30CBN Brown	310 ml Cartridge 25 per box
		• Concrete, galvanising and lead	SLLM30CDZ Dark Bronze	310 ml Cartridge 25 per box
		• Arbo MVP & Heel Bead Glazing Systems	SLLM30CTR Translucent	310 ml Cartridge 25 per box
			SLLM30CWH White	310 ml Cartridge 25 per box
			SLLM40CAN Anthracite	380 ml Cartridge 25 per box
			SLLM40CBF Buff	380 ml Cartridge 25 per box
			SLLM40CBN Brown	380 ml Cartridge 25 per box
			SLLM40CGR Grey	380 ml Cartridge 25 per box
			SLLM402564 Light Grey	380 ml Cartridge 25 per box
			SLLM40CPT Portland	380 ml Cartridge 25 per box
			SLLM40CRR Rustic Red	380 ml Cartridge 25 per box
			SLLM40CWH White	380 ml Cartridge 25 per box
			SLLM40CMAG Magnolia	380 ml Cartridge 25 per box
			SLLM40C7016 RAL7016	380 ml Cartridge 25 per box
		SLLM40C7022 LM RAL7022	380 ml Cartridge 25 per box	
	ARBOSIL 1090	• Curtain walls	SL9040CBF Buff	380 ml Cartridge 25 per box
		• Cladding	SL9040CBF Black	380 ml Cartridge 25 per box
		• Aluminium	SL9040CDZ Dark Bronze	380 ml Cartridge 25 per box
		• Concrete	SL9040CGR Grey	380 ml Cartridge 25 per box
		• Stone Brickwork	SL9040CPT Portland	380 ml Cartridge 25 per box
		• Windows • Marine	SL9040C2233 Pine	380 ml Cartridge 25 per box
		• Caravan sealing and gutter joints	SL9040CRR Rustic Red	Special Order
			SL9040CTK Teak	Special Order



Silicone Sealants (Cont'd)

PRODUCT	APPLICATIONS	CODE	COLOUR	SIZE	
 <p>ARBOSIL 1096 Low Modulus Silicone Sealant to ISO11600 F/G 25 LM</p>	<ul style="list-style-type: none"> Perimeter pointing of aluminium and PVCU windows Cladding panels Metal sheeting Glass to glass joints Glazing in accordance with GGF, NHBC & BS 8000 recommendations 	SL9640CAN	Anthracite	380 ml Cartridge	25 per box
		SL9640CBL	Black	380ml Cartridge	25 per box
		SL9640CGR	Grey	380 ml Cartridge	25 per box
		SL9640CMG	Mahogany	380 ml Cartridge	25 per box
		SL9640CTR	Translucent	380 ml Cartridge	25 per box
		SL9640CWH	White	380 ml Cartridge	25 per box
		SL9640C7016	RAL 7016	380 ml Cartridge	25 per box
SL9660PBL	Black (Special)	600 ml Foil Pack	20 per box		
 <p>ARBOSIL XL1099 Non Staining Silicone Sealant for Natural Stone to ISO11600 F/G 20 LM</p>	<ul style="list-style-type: none"> Cladding Perimeter floor joints Aluminium Coated steel PVCU window frames <p>Substrate or RAL no. colour matching available for 380 ml cartridges with a lead time of 6 weeks, subject to MOQ 200, 350, 500, 750, 950, or 1750 cartridges.</p>	SL9940CBF	Buff	380ml Cartridge	25 per box
		SL9938CBL	Black	380ml Cartridge	25 per box
		SL9940CGR	Grey	380ml Cartridge	25 per box
		SL9940CLS	Limestone	380ml Cartridge	25 per box
		SL9940CPT	Portland	380ml Cartridge	25 per box
		SL9940CWH	White	380ml Cartridge	25 per box
		SL9940CAN	Anthracite	380ml Cartridge	25 per box
		SL9940CRR	Rustic Red *	380ml Cartridge	25 per box
		SL9940CTG	Terracotta *	380ml Cartridge	25 per box
		* Subject to special order – MOQ of 200 380 ml cartridges			
 <p>ARBO LEAD SEAL Low Modulus Silicone Sealant to ISO11600 F/G 25 LM</p>	<ul style="list-style-type: none"> Sealing and jointing of lead sheet and flashings <p>Approved by Lead Contractors Association</p>	SLLEAD30CGR	Grey	310 ml Cartridge	25 per box
 <p>ARBOSIL HM General Purpose Silicone Sealant to ISO11600 F/G 25 HM</p>	<ul style="list-style-type: none"> Sanitary Sealant Perimeter pointing Glass to glass joints Baths, showers & washbasins General purpose silicone sealant 	SLHM30CAL	Aluminium	310 ml Cartridge	25 per box
		SLHM30CBL	Black	310 ml Cartridge	25 per box
		SLHM30CJA	Jasmine	310 ml Cartridge	25 per box
		SLHM30CTR	Translucent	310 ml Cartridge	25 per box
		SLHM30CWH	White	310 ml Cartridge	25 per box
SLHM30CMH	HM Manhattan	310 ml Cartridge	25 per box		
 <p>ARBOSIL 1081 High Modulus Silicone Sealant to ISO11600 F/G 20 LM</p>	<ul style="list-style-type: none"> Curtain walls Tiling Baths / showers / washbasins Shop fronts and glass to glass joints <p>Translucent only suitable for use in fish tanks and aquariums</p>	SL8130CBL	Black	310 ml Cartridge	25 per box
		SL8130CTR	Translucent (no fungicide)	310 ml Cartridge	25 per box
		SL8130CWH	White	310 ml Cartridge	25 per box
 <p>GENERAL PURPOSE BUILDING SILICONE LMA</p>	<ul style="list-style-type: none"> PVCU windows Certain plastic sheets with an appropriate primer 	SLGB30CTR	Translucent	310 ml Cartridge	25 per box
		SLGB30CWH	White	310 ml Cartridge	25 per box

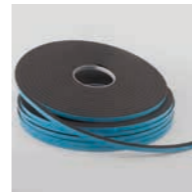

Mastic Sealant

PRODUCT	APPLICATIONS	CODE	COLOUR	SIZE		
 <p>ARBOMAST GP Oil based General Purpose Mastic</p>	<ul style="list-style-type: none"> Painted steel & wooden window / door frames Concrete garage sections Timber and concrete <p>* Subject to special order – MOQ of 200 380 ml cartridges</p>	FCGP40CGR	Grey	380 ml Cartridge		
		FCGP40CNT	Natural*	380 ml Cartridge		
		FCGP40CWH	White	380 ml Cartridge		
		FCGP40CBL	Black			
 <p>ARBOMAST BR Butyl Rubber Sealant</p>	<ul style="list-style-type: none"> Steel stanchions to concrete Storage tanks Lap Joints Cast iron Vehicles Flanges Brickwork Bolts Fittings and marine bedding 	FGBR40CGR	Grey	380 ml Cartridge	25 per box	
 <p>ARBOMAST AUTOGRADE Oil Based Mastic</p>	<ul style="list-style-type: none"> Sealing or resealing of gasketed windscreens 	MAAU40CBL	Black	380 ml Cartridge	25 per box	



Structural silicone

PRODUCT	PRODUCT CODE	THICKNESS	REEL LENGTH
 <p>ARBO SST Structural Spacer Tape compatible with Structural Silicone</p>	FCSST03XX15	3 mm	15 m
	FCSST06XX15	6 mm	15 m
	FCSST08XX15	8 mm	7.5 m
	FCSST95XX15	9.5 mm	7.5 m
<p>Tested and Approved by major manufacturers</p> <ul style="list-style-type: none"> For use as the spacer element between glass and the frame during structural glazing fabrication where the primary bond is structural silicone Some common sizes in stock Other sizes can be sent within 7 days Individual widths cut to order – minimum quantity applies. 			
PRODUCT	CODE	COLOUR	SIZE
 <p>ULTRAGLAZE SSG4000</p>	FCSSG400B310	Black	310 ml Cartridge
			24 per box





Modified Polymer Sealants

PRODUCT	APPLICATIONS	CODE	COLOUR	SIZE	
 ARBOMERIC MP10 One-Part Low Modulus Modified Polymer Sealant to ISO11600 F 20 LM	• Lightweight cladding	MS10140CBF	Buff	380 ml Cartridge	25 per box
	• Blockwork and brickwork	MS10140CGR	Grey	380 ml Cartridge	25 per box
	• Curtain walling	MS10140CLS	Limestone	380 ml Cartridge	25 per box
		MS10140CPT	Portland	380 ml Cartridge	25 per box
		MS10140CWH	White	380 ml Cartridge	25 per box
 ARBOMERIC MP20 One-Part High Modulus Modified Polymer Sealant to ISO11600 F 20 HM	• Heavy cladding	MS10240CBL	Black	380 ml Cartridge	25 per box
	• Floor joints	MS10240CGR	Grey	380 ml Cartridge	25 per box
	• Heavy trafficked areas	MS10240CWH	White	380 ml Cartridge	25 per box
		MS10260PGR	Grey	600 ml Foils	20 per box





EPOXY Sealants

PRODUCT	APPLICATIONS	CODE	COLOUR	SIZE	
 ARBOKOL SECURE Two Part Epoxy Sealant	• Prisons -perimeter sealing of doors and windows	AK2512SECWH	Off White	1.2 Ltr Tin	6 per box
	• Fixing and sanitary ware	AK02512SECGR	Grey		
 ARBOKOL 1025SP Two Part Epoxy Sealant	• Swimming Pools	AK02512SPWH	Off White	1.2 Ltr Tin	6 per box
	• Compression Joints	AK02512SPGR	Grey		
 ARBO 2020 Two Part Epoxy Sealant	• Internal floor joints	AK20225PNT	Natural	2.0 Litre Pack	4 per box
	• Colourisers available in: Red, Stone, Oatmeal, Maize, Buff, Light Brown, Grey, Black other colours available to order.		* Colourisers Available		



Polysulphide Sealants

PRODUCT	APPLICATIONS	CODE	COLOUR	SIZE	
 ARBOKOL 1000 One Part Polysulphide sealant to ISO11600 F12.5P	• Brickwork	AK10040CBL	Black	380 ml Cartridge	25 per box
	• Concrete	AK10040CGR	Grey	380 ml Cartridge	25 per box
	• Copings	AK10040CTK	Teak	380 ml Cartridge	25 per box
	• Perimeter sealing of windows	AK10040CWH	White	380 ml Cartridge	25 per box
	• Steel and marine / bedding				
 ARBOKOL 2150 High Modulus Two Part Polysulphide sealant to ISO11600 F25HM	• Heavily trafficked floor joints	AK15020PGR	Grey	2.0 Litre Pack	4 per box
	• Joints requiring a high degree of chemical resistance	AK15020PBL	Black	2.0 Litre Pack	4 per box
 ARBOKOL 682 Two Part Epoxy Polysulphide sealant Glass balustrades in accordance with BS 6180:1999	• Insulating glass units	AK68212PGR Gun Grade	Grey	1.2 Litre Pack	6 per box
	• Internal, low movement trafficked joints	AK68212PGDGR Pouring Grade	Grey	1.2 Litre Pack	6 per box
		AK682100GR	Grey	100 Litre Set	
 ARBOKOL AG2 GUN GRADE Two Part Polysulphide sealant to ISO11600 F25 LM	• Floor joints	AKAG225PGR	Grey	2.5 Litre Pack	4 per box
	• Expansion joints				
	• Joints in water retaining surfaces				
 ARBOKOL AG2 POURING GRADE Two Part Polysulphide sealant to B55212 Type FB	• Floor joints	AKPG250PGR	Grey	5 Litre Pack	2 per box
	• Lay-bys				
	• Hard standings				

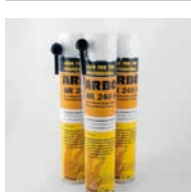

Intumescent and Fire Resisting Mastics and Sealants

PRODUCT	APPLICATIONS	CODE	COLOUR	SIZE	
 ARBOSIL 1070 Fire Resisting Low Modulus Silicone Sealant to ISO11600 F/G 25 LM	<ul style="list-style-type: none"> • Expansion joints • Glazing • Windows and doors • Blockwerk and brickwork 	SL7040CBL	Black	380 ml Cartridge	25 per box
		SL7040CGR	Grey	380 ml Cartridge	25 per box
 ARBOSIL 1071 Fire Resisting Silicone Sealant	<ul style="list-style-type: none"> • Expansion joints • Glazing • Windows and doors • Blockwerk and brickwork 	SL7140CWH	White	380 ml Cartridge	25 per box
 ARBO XL 1075 Intumescent Water Based Acrylic Sealant to ISO11600 F 7.5P	<ul style="list-style-type: none"> • Internal joints • Fire resistant doors • Partitions • Blockwerk and brickwork 	AC07540CGR	Grey	380 ml Cartridge	25 per box
		AC07540CWH	White	380 ml Cartridge	25 per box
 ARBOSEAL INTUMESCENT TAPE Single Reel Extrusion	<ul style="list-style-type: none"> • Glazing of fire resistant doors and windows • Add a second point HVAC ducting 	TPINN153STK	Teak	12 m x 15 mm x 3 mm	16 per box
		TPINN153SWH	White	12 m x 15 mm x 3 mm	16 per box
 ARBO AR240 FIRE RATED FOAM One Part Fire Rated Expanding Polyurethane Foam	<ul style="list-style-type: none"> • Joints in fire walls 	Gun Grade	Pink	750 ml Aerosol Can	12 per box
		FCAR24075G	Pink	750 ml Aerosol Can	12 per box
		Hand Grade	Pink	750 ml Aerosol Can	12 per box
		FCAR24075H			



Polyurethane Sealants

PRODUCT	APPLICATIONS	CODE	COLOUR	SIZE	
 ARBOTHANE 1245 One Part High Modulus Polyurethane Sealant to ISO11600 F 25HM	<ul style="list-style-type: none"> • Flooring • Expansion joints 	PU12560PGR	Grey	600 ml Foil Pack	20 per box
 ARBOTHANE 1245SL One part self-leveling Polyurethane Sealant	<ul style="list-style-type: none"> • Pedestrian walkways • Flooring • Expansion joints 	PU12560SLG	Grey	600 ml Foil Pack	20 per box

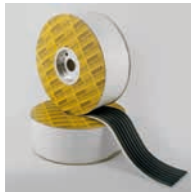

Cleaners

PRODUCT	CODE	SIZE	
 ARBO GLASS CLEANER	FCAGC1L	1.0 Litre Bottle	12 per box
 ARBO UPVC CLEANER	FCPVCCC1	1.0 Litre Bottle	12 per box
	FCPVCSC1	1.0 Litre Bottle	12 per box
 ARBO CLEANERS	Type 15 Cleaner	Type 15 PRC1510T	500 ml Tin
	Type 16 Cleaner	Type 16 PRC1610T	1.0 Litre Tin
	Type 17 Cleaner	Type 17 PRC1710T	1.0 Litre Tin



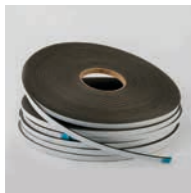

Butyl Glazing Tapes

PRODUCT	APPLICATIONS	CODE	COLOUR	SIZE	
 <p>ARBOSEAL GZ Single Reel Extrusion</p>	<ul style="list-style-type: none"> • Glazing • Lap joints in metal sheets • Gutter joints 	TPGZN103SBL	Black	12 m x 10 mm x 3 mm	20 per box
		TPGZN103SWH	White	12 m x 10 mm x 3 mm	20 per box
		TPGZN123SBL	Black	12 m x 12 mm x 3 mm	20 per box
		TPGZN123STK	Teak	12 m x 12 mm x 3 mm	20 per box
		TPGZN123SWH	White	12 m x 12 mm x 3 mm	20 per box
		TPGZN153SBL	Black	12 m x 15 mm x 3 mm	16 per box
		TPGZN153STK	Teak	12 m x 15 mm x 3 mm	16 per box
		TPGZN153SWH	White	12 m x 15 mm x 3 mm	16 per box
		TPGZN183SBL	Black	12 m x 18 mm x 3 mm	12 per box
		TPGZN223SBL	Black	12 m x 22 mm x 3 mm	12 per box
		TPGZN353SBL	Black	12 m x 35 mm x 3 mm	8 per box
		TPGZN503SBL	Black	12 m x 50 mm x 3 mm	4 per box
		TPGZN506SBL	Black (Special Order Only)	6 m x 50 mm x 6 mm	4 per box
		 <p>ARBOSEAL BUTYL 88 No. 3 Reel</p>	<ul style="list-style-type: none"> • Lap joints in profiled sheets <p>Special Order Product</p>	TPB8306DBL	Black
TPB8308DBL	Black			27.0 m x 8 mm Dia	4 per box
 <p>BUTYL STRIP SEALANT Single Reel Extrusion</p>	<ul style="list-style-type: none"> • Profiled steel and aluminium sheeting • Overlapping composite panels • Class 'A' 	TPGZN04SGWGR	Goose Wing Grey	4 mm bead x 12 m	30 per box
		TPGZN06SGWGR	Goose Wing Grey	6 mm bead x 8 m	30 per box
		TPGZN08SGWGR	Goose Wing Grey	8 mm bead x 6 m	30 per box
		TPGZN0605SGWGR	Goose Wing Grey	6 mm x 5 mm x 9.6 m	30 per box
		TPGZN0903SGWGR	Goose Wing Grey	9 mm x 3 mm x 15 m	24 per box





Self Adhesive Foam Tapes

PRODUCT	APPLICATIONS	CODE	COLOUR	SIZE	
 <p>ARBOSTRIP F42 Self Adhesive Foam Tape – supplied in reels</p>	<ul style="list-style-type: none"> • Glazing of internal screens 	FCF42063BL	Black	20 m x 6 mm x 3 mm	30 per box
		FCF42093BL	Black	20 m x 9 mm x 3 mm	20 per box
		FCF42123BL	Black	20 m x 12 mm x 3 mm	15 per box
		FCF4216BL	Black	12 mm x 12 mm x 6 mm	15 per box
 <p>ARBOSTRIP F90 Self Adhesive Foam Tape – supplied in reels</p>	<ul style="list-style-type: none"> • Glazing in conjunction with Arbosil 1096 & Arbosil LM, in accordance with NHBC, GGF & BS 8000 recommendations 	FCF90064GR	Grey	15 m x 6 mm x 4.5 mm	30 per box
		FCF90094GR	Grey	15 m x 9 mm x 4.5 mm	20 per box
		FCF90095GR	Grey	12 m x 9 mm x 6 mm	20 per box
		FCF90124GR	Grey	15 m x 12 mm x 4.5 mm	15 per box
		FCF90125GR	Grey	12 m x 12 mm x 6 mm	15 per box

Other products

PRODUCT	APPLICATIONS	CODE	COLOUR	SIZE	
 <p>ARBO SMALL GAP SEALER</p>	<ul style="list-style-type: none"> • Suitable for sealing of mitre joints, screws and hinges in the construction of anodised or mill finished aluminium frames • See accessories for application tools 	AKSGS05TTR	Clear	500 ml Tin	12 per box
		AKSGS05TWH	White	500 ml Tin	12 per box
		AKSGS30CWH	White	300 ml Cartridge	25 per box
		AKSGS30CTR	Clear	300 ml Cartridge	25 per box
		FCPA5 Small Gap Applicator	-	for 500 ml	
 <p>HIGH VISCOSITY SMALL GAP SEALER</p>	<ul style="list-style-type: none"> • Jointing & bonding PVC up to 5 mm wide 	HVSGS30CWH	White	300 ml Cartridge	25 per box
 <p>ARBOFOAM One Component Expanding Polyurethane Foam</p>	<ul style="list-style-type: none"> • Type R (Complete with own nozzle) • Type G (For use with Arbofoam Gun) • Metal Gun for Arbofoam G • Aerosol Cleaner for Arbofoam Metal Gun (Can of pressurised solvent for cleaning Arbofoam guns after use) 	FCAF075R		750 ml Aerosol Can	12 per box
		FCAF075G		750 ml Aerosol Can	12 per box
		FCAF075M		Metal Gun	
		FCAF075A		500 ml tin	12 per box
 <p>ARBOGRIP TF Multi-Purpose Gap Filling Adhesive</p>		FCMPA30CNT	Natural	300 ml Cartridge	25 per box
 <p>ARBO MASONRY WATER REPELLENT To BS6477 Groups 1,2 & 3 MOQ applies</p>		PRMWR25D		25.0 Litre Drum	single
		PRMWR50T		5.0 Litre Tin	

Primers and Backing Materials

PRODUCT	CODE	BOX QUANTITY	SIZE
ARBO PRIMERS			
	925 Primer for Arbokol 1000	PR92505T	500ml Tin 12 per box
	7750 Arbo Primer for Arbokol 1000	PR77505T	500ml Tin 12 per box
	2172 Arbo Primer for Arbosil	PR21705T	500ml Tin 12 per box
	2402 Arbo Primer for Arbosil	PR24005T	500ml Tin 12 per box
	2650 Arbo Primer for Arbosil and Arbomeric	PR26505T	500ml Tin 12 per box
	AG2 Porous Primer for Arbokol and 1245	PRPOR05T	500ml Tin 12 per box
	AG2 Porous Primer for Arbokol and 1245	PRPOR50T	5 Ltr Tin single
	AFS PRIMER	PRAFS10T	1 Ltr Tin 10 per box
ARBOFOAM POLYETHYLENE JOINT BACKING			
	Arbo Closed Cell Foam		
	FCFT06D	2500 Mtr	1 m x 6 mm Dia
	FCFT10D	1100 Mtr	1 m x 10 mm Dia
	FCFT12D	900 Mtr	1 m x 12 mm Dia
	FCFT15D	500 Mtr	1 m x 15 mm Dia
	FCFT20D	300 Mtr	1 m x 20 mm Dia
	FCFT25D	200 Mtr	1 m x 25 mm Dia
	FCFT30D	150 Mtr	1 m x 30 mm Dia
	FCFT40D	80 Mtr	1 m x 40 mm Dia
	FCFT50D	50 Mtr	1 m x 50 mm Dia
	FCFR0906	250 Strips Per Pack	2 m x 9 mm x 6 mm
	FCFR1206	250 Strips Per Pack	2 m x 12 mm x 6 mm
	FCFR1210	250 Strips Per Pack	2 m x 12 mm x 10 mm
	FCFR1812	250 Strips Per Pack	2 m x 18 mm x 12 mm
	FCFR2512	250 Strips Per Pack	2 m x 25 mm x 12 mm
	FCFR2525	250 Strips Per Pack	2 m x 25 mm x 25 mm
	FCFR3015	250 Strips Per Pack	2 m x 30 mm x 15 mm
ARBO BOND BREAKER TAPE			
	FCBB06		50 m x 6 mm
	FCBB10		50 m x 10 mm
	FCBB12		50 m x 12 mm
	FCBB20		50 m x 20 mm
ARBO MASKING TAPE			
	FCMT25		50 m x 25 mm
ARBO TOOLING ACCESSORIES			
	FCSTB		Silicone Tooling Block
	FCTS		Set of 4 Tooling Sticks

Caulking Guns and Accessories

PRODUCT	CODE	
ARBO CAULKING GUNS & ACCESSORIES		
	Skeleton Gun	FCSG
	Professional Gun 12:1 Ratio	FCPG1
	Battery Operated Gun 400 ml (up to 6 weeks lead time)	FCBG4
	Battery Operated Gun 600 ml (up to 6 weeks lead time)	FCBG6
	Hand Barrel Gun XL Steel Inc. Nozzles	FCHBG5XQ
	Foil Pack Gun	FCFPG600
	Plastic Nozzle for Hand Barrel Gun 12 mm, Type QF	FCHBG12PN
	Plastic Nozzle for Hand Barrel Gun 9 mm, Type QF	FCHBG09PN
	Plastic Nozzle for Hand Barrel Gun 6 mm, Type QF	FCHBG06PN
	Plastic Large Cone Nozzle, Type MN	FCHBGCOPN
	Plastic End Cap Ring (for Hand Barrel Gun)	FCHBGPEC
	Green Plunger (for Hand Barrel Gun)	FCHBGPL
	Hand Barrel Gun Nozzle Holder	FCZDNH
	Air Operated Gun (for 310 ml Cartridges)	FCA0G3RC
	Air Operated Gun (for 380 ml Cartridges)	FCA0G4RC
MIXING ACCESSORIES		
	Standard Mixing Paddle	FCKMP102
	Long Spiral Mixing Paddle	FCKMPEX
	Heavy Duty Follow Plate (for 1.2 Litre Tins)	FCPFA12HD
	Standard Follow Plate (for 1.2 Litre Tins)	FCPFA12T
	Heavy Duty Follow Plate (for 2.0 Litre Tins)	FCPFA2LHD
	Empty 380 ml Cartridges	FCECD4
PLUNGERS AND NOZZLES		
	Plastic Plunger (for 380 ml Cartridges)	FCPPL
	Standard Nozzles (for 310 ml Cartridges)	FCPNS
	Long Nozzles (for 310 ml Cartridges)	FCPNSXL
	Variable Angle Nozzles (for 310 ml Cartridges)	FCPNBWW
	Standard Nozzles (for 380 ml Cartridges)	FCPN
	Adaptor (for 310 ml/380 ml Nozzles)	FCFPG310AD
	Blue Sachet Plunger	FCBSP
	Domed Blue Sachet Plunger	FCBDP
BRUSHES		
	75 mm / 3" Dusting Brush	FCPB3
	12 mm / 1/2" Priming Brush	FCPB5
GLOVES AND WIPES		
	Gripz Gloves	FCGLOVEGRP
	Latex Gloves (100 Per Box)	FCGLOVE
	Two Ply Small Blue Wipes	FCDPWSBL

Caulking Guns and Accessories (Cont'd)

PRODUCT	CODE
KNIVES AND SCRAPERS	
Arbo Hacking Knife	FCAHK
Arbo Hooking Knife	FCKNHO
Arbo Putty Knife	FCAPK
Stanley Knife	FCKNS
Heavy Duty Knife Blades (5 Pack)	FCSKB
Titan Stanley Knife	FCKNST
Palette Knife 152 mm	FCPK152
Palette Knife 250 mm	FCPK250
Paint Scraper 75 mm	FCPS075
Paint Scraper 102 mm	FCPS102
Stanley Window Scraper	FCSWS
Snap off Knives	FCKNBA
Snap off Knife Blades (10)	FCKNB10
Deluxe Window Scraper	FCDWS
Deluxe Window Scraper Blades (10)	FCDWSBL
Arbo Glazing Shovel	FCGSH
ARBO G CLAMPS	
150 mm Plastic Feet	FCAGC150P
GLAZING BLOCKS	
75 mm x 25 mm x 3 mm (250 per Bag)	FCDS75253
50 mm x 12.5 mm x 3 mm (500 per Bag)	FCDS50123
50 mm x 25 mm x 3 mm (500 per Bag)	FCDS50253
25 mm x 22 mm x 3 mm (1000 per Bag)	FCDS25223
25 mm x 12.5 mm x 3 mm (1000 per Bag)	FCDS25123
25 mm x 12.5 mm x 6 mm (1000 per Bag)	FCDS25126
25 mm x 6 mm x 1.5 mm (2000 per Bag)	FCDS25062
25 mm x 6 mm x 3 mm (2000 per Bag)	FCDS25063
25 mm x 9 mm x 3 mm (2000 per Bag)	FCDS25093
25 mm x 9 mm x 6 mm (1000 per Bag)	FCDS25096
25 mm x 12.5 mm x 1.5 mm (2000 per Bag)	FCDS25121
Wedge Shaped 25 mm x 22 mm x 3 mm (500 per Bag)	FCWS25223



ARENA CENTRAL



EVELINA HOSPITAL



SEA CONTAINER HOUSE



ST. CATHERINES COLLEGE

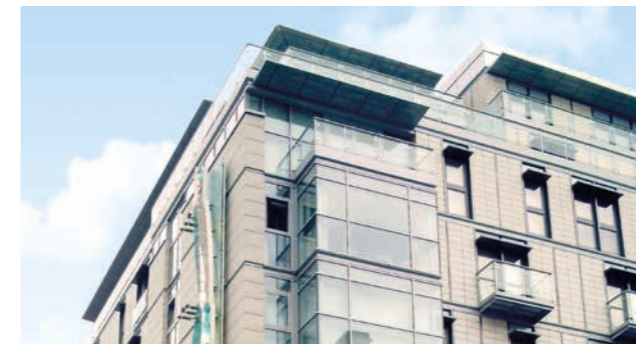

TESCO & APARTMENTS



TOWER BRIDGE



HIGHCROSS LEICESTER



THE GATEWAY LINCOLN

CARLISLE®
Adshead Ratcliffe & Co Ltd.

United Kingdom

Derby Road, Belper,
Derbyshire,
DE56 1WJ

T +44 (0)1773 826661
F +44 (0)1773 821215
E arbo@arbo.co.uk

www.ccm-europe.com