



INSTYTUT TECHNIKI BUDOWLANEJ
PL 00-611 WARSZAWA
ul. Filtrowa 1
tel.: (+48 22) 825-04-71
(+48 22) 579-62-94
eta@itb.pl
www.itb.pl



Member of



European Technical Assessment

**ETA-21/0244
of 30/12/2021**

General Part

Technical Assessment Body issuing the European Technical Assessment

Instytut Techniki Budowlanej

Trade name of the construction product

R-KEX-II

Product family to which the construction product belongs

Bonded fasteners with threaded rod, rod with inner thread and rebar for use in concrete

Manufacturer

RAWLPLUG S.A.
ul. Kwidzyńska 6
51-416 Wrocław
Poland

Manufacturing plant

Manufacturing Plant no. 3

This European Technical Assessment contains

38 pages including 3 Annexes which form an integral part of this Assessment

This European Technical Assessment is issued in accordance with regulation (EU) No 305/2011, on the basis of

European Assessment Document EAD 330499-01-0601 "Bonded fasteners for use in concrete"

This version replaces

ETA-21/0244 issued on 11/03/2021

This European Technical Assessment is issued by the Technical Assessment Body in its official language. Translations of this European Technical Assessment in other languages shall fully correspond to the original issued document and should be identified as such.

Communication of this European Technical Assessment, including transmission by electronic means, shall be in full. However, partial reproduction may be made, with the written consent of the issuing Technical Assessment Body. Any partial reproduction has to be identified as such.

Specific Part

1 Technical description of the product

The R-KEX-II are bonded anchors (injection type) consisting of a injection mortar cartridge using an applicator gun equipped with a special mixing nozzle and steel element.

The steel element consists of:

- threaded anchor rod sizes M8 to M30 made of:
 - galvanized carbon steel,
 - carbon steel with zinc flake coating,
 - stainless steel,
 - high corrosion resistant stainless steel,

with hexagon nut and washer,

- anchor rod with inner thread sizes M6/Ø10 to M16/Ø24 made of:
 - galvanized carbon steel,
 - stainless steel,
 - high corrosion resistant stainless steel,
- rebar sizes Ø8 to Ø32.

The steel element is placed into a drilled hole previously injected (using an applicator gun) with a mortar with a slow and slight twisting motion. The rod or rebar is anchored by the bond between steel element and concrete.

The product description is given in Annex A.

2 Specification of the intended use in accordance with the applicable European Assessment Document (EAD)

The performances given in Section 3 are only valid if the anchors are used in compliance with the specifications and conditions given in Annex B.

The provisions given in this European Technical Assessment are based on an assumed working life of the anchor of 50 and/or 100 years. The indications given on the working life cannot be interpreted as a guarantee given by the producer or the Technical Assessment Body, but are to be regarded only as a means for choosing the right products in relation to the expected economically reasonable working life of the works.

3 Performance of the product and references to the methods used for its assessment

3.1 Performance of the product

3.1.1 Mechanical resistance and stability (BWR 1)

Essential characteristic	Performance
Characteristic resistance to static and quasi-static loading, displacements	See Annexes C1 to C13
Characteristic resistance to seismic performance category C1, displacements	See Annexes C14 to C16
Characteristic resistance to seismic performance category C2, displacements	See Annex C17

3.1.2 Hygiene, health and the environment (BWR 3)

No performance assessed.

3.2 Methods used for the assessment

The assessment has been made in accordance with the EAD 330499-01-0601.

4 Assessment and verification of constancy of performance (AVCP) system applied, with reference to its legal base

According to Decision 96/582/EC of the European Commission the system 1 of assessment and verification of constancy of performance applies (see Annex V to regulation (EU) No 305/2011).

5 Technical details necessary for the implementation of the AVCP system, as provided for in the applicable European Assessment Document (EAD)

Technical details necessary for the implementation of the AVCP system are laid down in the control plan deposited at Instytut Techniki Budowlanej.

For type testing the results of the tests performed as part of the assessment for the European Technical Assessment shall be used unless there are changes in the production line or plant. In such cases the necessary type testing has to be agreed between Instytut Techniki Budowlanej and the notified body.

Issued in Warsaw on 30/12/2021 by Instytut Techniki Budowlanej

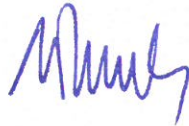

Anna Panek, MSc
Deputy Director of ITB

Threaded anchor rods

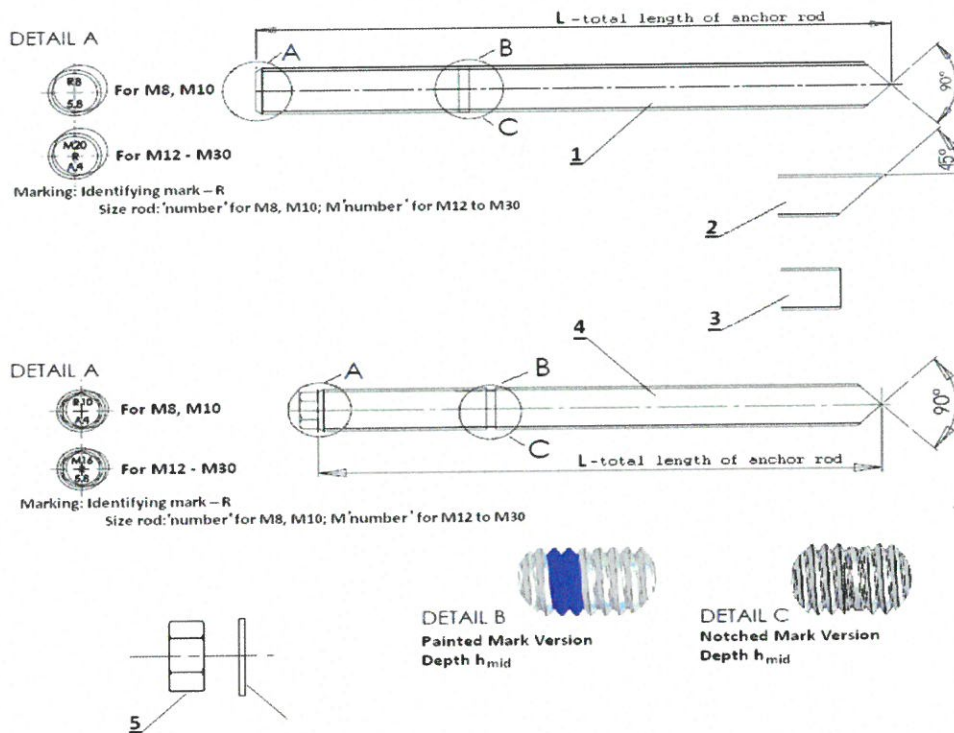

- 1. Anchor rod R-STUDS
- 2. 45° shape with anchor rod
- 3. The flat end of anchor rod
- 4. Anchor rod R-STUDS
- 5. Hexagonal nut
- 6. Washer

R-KEX-II	Annex A1 of European Technical Assessment ETA-21/0244
Product description Threaded anchor rods	

Anchor rods with inner thread

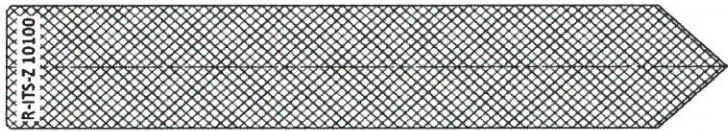
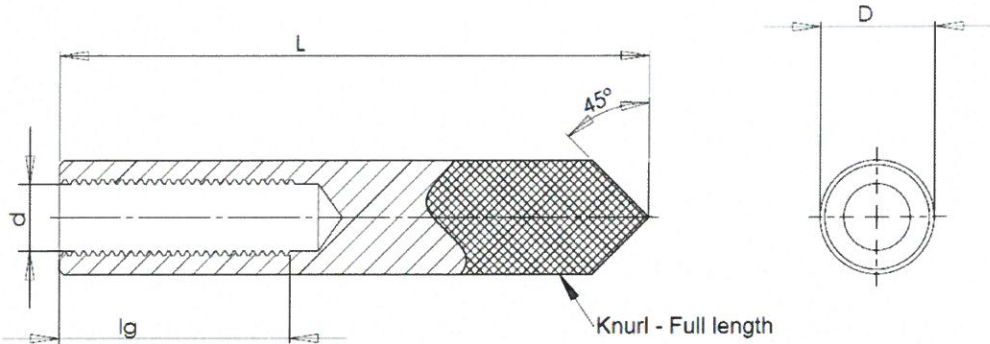

Marking: R - Identifying mark
 ITS - product index
 Z - carbon steel or A4 - stainless steel
 XX - thread size
 YYY - length of sleeve

Rebar

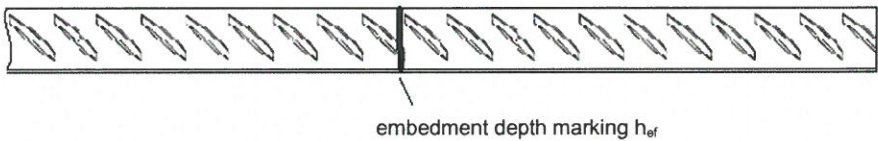

R-KEX-II	Annex A2 of European Technical Assessment ETA-21/0244
Product description Anchor rods with inner thread and rebar	

Table A1: Threaded rods

Part	Designation		
	Steel, zinc plated	Stainless steel	High corrosion resistance stainless steel (HCR)
Threaded rod	Steel, property class 5.8 to 12.9 acc. to EN ISO 898-1 electroplated $\geq 5 \mu\text{m}$ acc. to EN ISO 4042 or hot-dip galvanized $\geq 45 \mu\text{m}$ acc. to EN ISO 10684 or non-electrolytically applied zinc flake coating $\geq 8 \mu\text{m}$ acc. EN ISO 10683 elongation at fracture $A_5 > 8\%$	Steel 1.4401, 1.4404, 1.4571 acc. to EN 10088; property class 70 and 80 (A4-70 and A4-80) acc. to EN ISO 3506 Corrosion resistance class CRC III acc. to EN 1993-1-4:2006+A1:2015 elongation at fracture $A_5 > 8\%$	Steel 1.4529, 1.4565, 1.4547 acc. to EN 10088; property class 70 acc. to EN ISO 3506 Corrosion resistance class CRC V acc. to EN 1993-1-4:2006+A1:2015 elongation at fracture $A_5 > 8\%$
Hexagon nut	Steel, property class 5 to 12, acc. to EN ISO 898-2; electroplated $\geq 5 \mu\text{m}$ acc. to EN ISO 4042 or hot-dip galvanized $\geq 45 \mu\text{m}$ acc. to EN ISO 10684 or non-electrolytically applied zinc flake coating $\geq 8 \mu\text{m}$ acc. EN ISO 10683	Steel 1.4401, 1.4404, 1.4571 acc. to EN 10088; property class 70 and 80 (A4-70 and A4-80) acc. to EN ISO 3506 Corrosion resistance class CRC III acc. to EN 1993-1-4:2006+A1:2015	Steel 1.4529, 1.4565, 1.4547 acc. to EN 10088; property class 70 acc. to EN ISO 3506 Corrosion resistance class CRC V acc. to EN 1993-1-4:2006+A1:2015
Washer	Steel, acc. to EN ISO 7089; electroplated $\geq 5 \mu\text{m}$ acc. to EN ISO 4042 or hot-dip galvanized $\geq 45 \mu\text{m}$ acc. to EN ISO 10684 or non-electrolytically applied zinc flake coating $\geq 8 \mu\text{m}$ acc. EN ISO 10683	Steel 1.4401, 1.4404, 1.4571 acc. to EN 10088 Corrosion resistance class CRC III acc. to EN 1993-1-4:2006+A1:2015	Steel 1.4529, 1.4565, 1.4547 acc. to EN 10088 Corrosion resistance class CRC V acc. to EN 1993-1-4:2006+A1:2015

- Commercial threaded rods (in the case of rods made of galvanized steel – standard rods with property class ≤ 8.8 only), with:
- material and mechanical properties according to Table A1,
 - confirmation of material and mechanical properties by inspection certificate 3.1 according to EN-10204:2004; the documents shall be stored,
 - marking of the threaded rod with the embedment depth.

Note: Commercial standard threaded rods made of galvanized steel with property class above 8.8 are not permitted in some Member States.

R-KEX-II	Annex A3 of European Technical Assessment ETA-21/0244
Product description Materials (1)	

Table A2: Rods with inner thread

Part	Designation		
	Steel, zinc plated	Stainless steel	High corrosion resistance stainless steel
Rod with inner thread	Steel, property class 5.8 to 8.8 acc. to EN ISO 898-1 electroplated $\geq 5 \mu\text{m}$ acc. to EN ISO 4042 or hot-dip galvanized $\geq 45 \mu\text{m}$ acc. to EN ISO 10684 elongation at fracture $A_5 > 8\%$	Steel 1.4401, 1.4404, 1.4571 acc. to EN 10088; property class 70 and 80 (A4-70 and A4-80) acc. to EN ISO 3506 Corrosion resistance class CRC III acc. to EN 1993-1-4:2006+A1:2015 elongation at fracture $A_5 > 8\%$	Steel 1.4529, 1.4565, 1.4547 acc. to EN 10088; property class 70 acc. to EN ISO 3506 elongation at fracture $A_5 > 8\%$

Table A3: Reinforcing bars (rebar) according to EN 1992-1-1, Annex C

Product form		Bars and de-coiled rods	
Class		B	C
Characteristic yield strength f_{yk} or $f_{0,2k}$ [N/mm ²]		400 to 600	
Minimum value of $k = (f_t / f_y)_k$		$\geq 1,08$	$\geq 1,15$ < 1,35
Characteristic strain at maximum force, ϵ_{uk} [%]		$\geq 5,0$	$\geq 7,5$
Bendability		Bend / Rebind test	
Maximum deviation from nominal mass (individual bar) [%]	Nominal bar size [mm]	$\pm 6,0$ $\pm 4,5$	
	≤ 8 > 8		
Bond: minimum relative rib area, $f_{R,min}$	Nominal bar size [mm]	0,040 0,056	
	8 to 12 > 12		

Rib height: The maximum rib height is: $h_{rib} \leq 0,07 \cdot \emptyset$

Table A4: Injection mortar

Product	Composition
R-KEX-II (two component injection mortar)	Epoxy system with fillers

R-KEX-II	Annex A4 of European Technical Assessment ETA-21/0244
Product description Materials (2)	

Side by side cartridge – 385 to 1100 ml

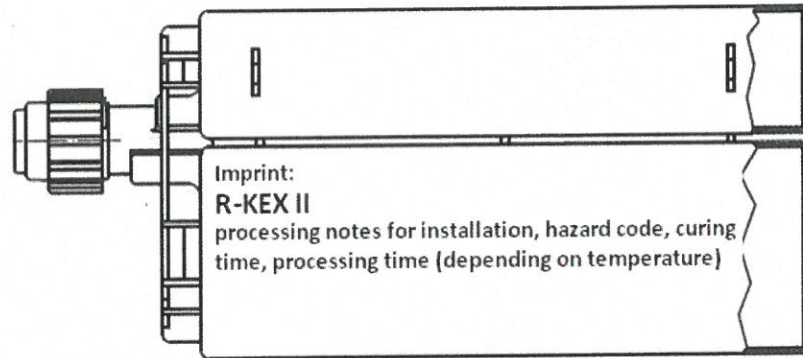

Mixer for cartridge

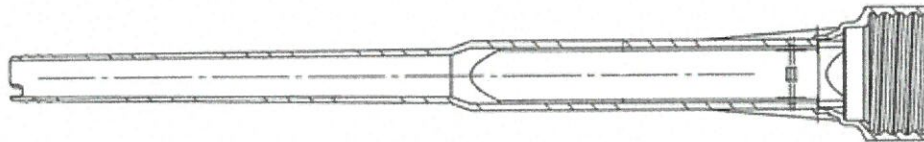

<p>R-KEX-II</p>	<p>Annex A5</p>
<p>Product description Cartridge type and size</p>	<p>of European Technical Assessment ETA-21/0244</p>

Specification of intended use

Anchors subject to:

Static and quasi-static loads: threaded rod size M8 to M30, rod with inner thread sizes M6/Ø10 to M16/Ø24 and rebar Ø8 to Ø32.

Seismic performance category C1: threaded rod size M8 to M30 and rebar Ø8 to Ø32.

Seismic performance category C2: threaded rod size M12 to M24.

Base material:

- Reinforced or unreinforced normal weight concrete of strength class C20/25 to C50/60 according to EN 206:2013+A1:2016.
- Cracked and uncracked concrete – threaded rod size M8 to M30 and rebar Ø8 to Ø32.
- Uncracked concrete only – rod with inner thread sizes M6/Ø10 to M16/Ø24.

Temperature ranges:

Installation temperature (temperature of substrate):

- +5°C to +30°C.

In-service temperature:

The anchors may be used in the following temperature range:

- -40°C to +40°C (max. short term temperature +40°C and max. long term temperature +24°C).
- -40°C to +80°C (max. short term temperature +80°C and max. long term temperature +50°C).

Use conditions (environmental conditions):

- Structures subject to dry internal conditions: all materials.
- For all other conditions according to EN 1993-1-4 corresponding to corrosion resistance class (CRC):
 - stainless steel A4 according to Annex A3, Table A1: CRC III,
 - high corrosion resistance steel (HCR) according to Annex A3, Table A1: CRC V.

Design methods:

- Anchorages are designed in accordance with EN 1992-4:2018 and Technical Report TR 055.
- Anchorages under seismic actions have to be designed in accordance with EOTA Technical Report TR 045.
- Anchorages are designed under the responsibility of an engineer experienced in anchorages and concrete work.
- Verifiable calculation notes and drawings are prepared taking account of the loads to be anchored. The position of the anchor is indicated on the design drawings (e.g. position of the anchor relative to reinforcement or to supports, etc.).

Installation:

- Dry or wet concrete (use category I1).
- Flooded holes (use category I2).
- Installation direction D3 (downward, horizontal and upwards installation).
- The anchors are suitable for hammer drilled holes or diamond core drilled holes.

R-KEX-II	Annex B1 of European Technical Assessment ETA-21/0244
Intended use Specification	

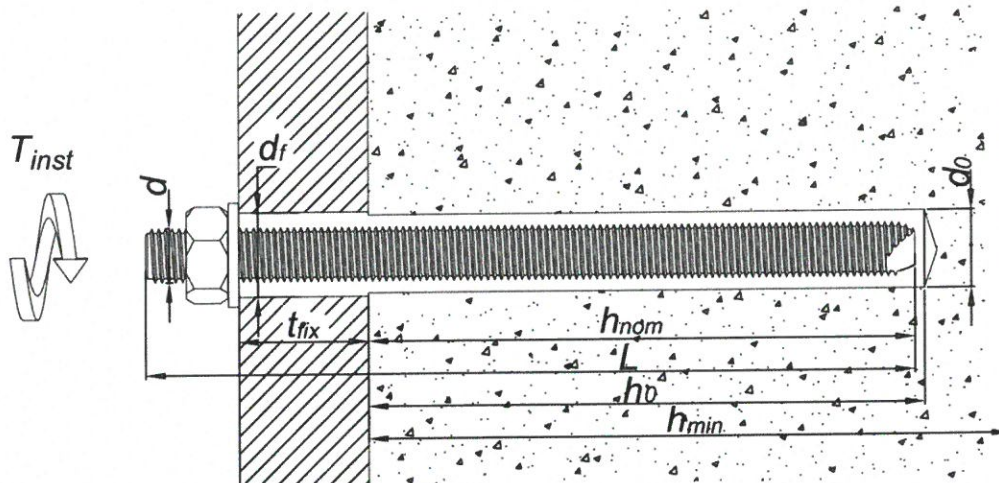

Table B1: Installation parameters – threaded anchor rod

Size		M8	M10	M12	M16	M20	M24	M30
Nominal drilling diameter	d_0 [mm]	10	12	14	18	22 or 24	28	35
Maximum diameter hole in the fixture	d_r [mm]	9	12	14	18	22	26	33
Effective embedment depth	$h_{ef,min}$ [mm]	60	70	80	100	120	140	165
	$h_{ef,max}$ [mm]	160	200	240	320	400	480	600
Depth of the drilling hole	h_0 [mm]	$h_{ef} + 5$ mm						
Minimum thickness of the concrete slab	h_{min} [mm]	$h_{ef} + 30$ mm; ≥ 100 mm			$h_{ef} + 2d_0$			
Maximum installation torque	$T_{inst,max}$ [Nm]	10	20	40	80	120	180	200
Minimum spacing	s_{min} [mm]	40	40	40	50	60	70	85
Minimum edge distance	c_{min} [mm]	40	40	40	50	60	70	85

R-KEX-II

Intended use
Installation parameters (1)

Annex B2
of European
Technical Assessment
ETA-21/0244

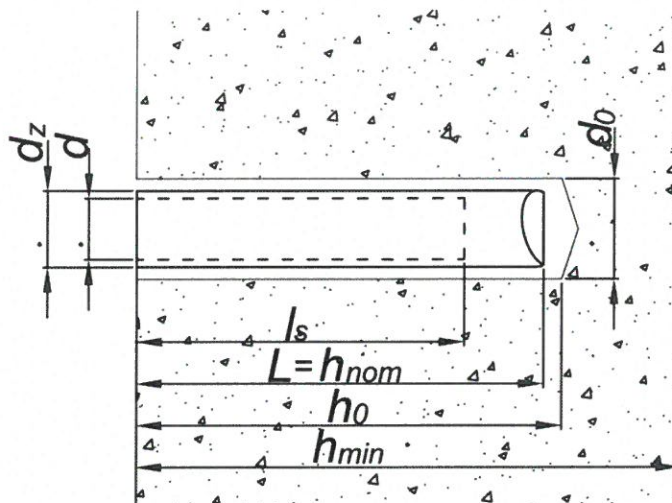

Table B2: Installation parameters – anchor rod with inner thread

Size		M6/ Ø10/ 75	M8/ Ø12/ 75	M8/ Ø12/ 90	M10/ Ø16/ 75	M10/ Ø16/ 100	M12/ Ø16/ 100	M16/ Ø24/ 125
Nominal drilling diameter	d_0 [mm]	12	14	14	20	20	20	28
Maximum diameter hole in the fixture	d_f [mm]	7	9	9	12	12	14	18
Effective embedment depth	$h_{ef} = h_{nom}$ [mm]	75	75	90	75	100	100	125
Thread length, min	l_s [mm]	24	25	25	30	30	35	50
Depth of the drilling hole	h_0 [mm]	$h_{ef} + 5 \text{ mm}$						
Minimum thickness of the concrete slab	h_{min} [mm]	$h_{ef} + 30 \text{ mm}; \geq 100 \text{ mm}$			$h_{ef} + 2d_0$			
Maximum installation torque	$T_{inst,max}$ [Nm]	3	5	5	10	10	20	40
Minimum spacing	s_{min} [mm]	40	40	50	40	50	50	70
Minimum edge distance	c_{min} [mm]	40	40	50	40	50	50	70

R-KEX-II

Intended use
Installation parameters (2)

Annex B3
of European
Technical Assessment
ETA-21/0244

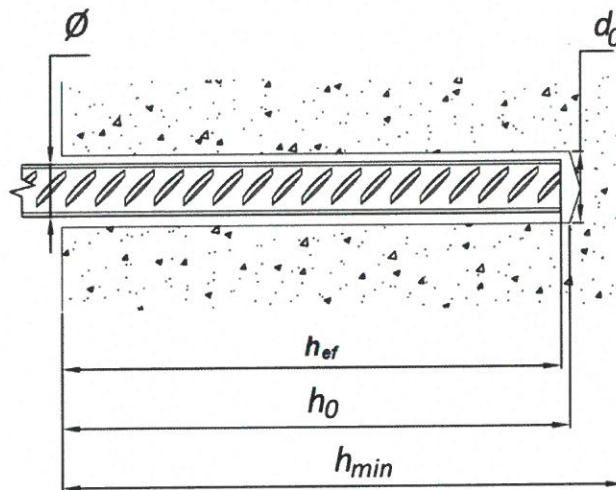

Table B3: Installation parameters – rebar

Size		Ø8	Ø10	Ø12	Ø14	Ø16	Ø20	Ø25	Ø32	
Nominal drilling diameter	d_0 [mm]	10 or 12	12 or 14	14 or 18	18	22	26	32	40	
Effective embedment depth	$h_{ef,min}$ [mm]	60	70	80	80	100	120	140	165	
	$h_{ef,max}$ [mm]	160	200	240	280	320	400	500	640	
Depth of the drilling hole	h_0 [mm]	$h_{ef} + 5$ mm								
Minimum thickness of the concrete slab	h_{min} [mm]	$h_{ef} + 30$ mm; ≥ 100 mm				$h_{ef} + 2d_0$				
Minimum spacing	s_{min} [mm]	40	40	40	40	50	60	70	85	
Minimum edge distance	c_{min} [mm]	40	40	40	40	50	60	70	85	

R-KEX-II

Intended use
Installation parameters (3)

Annex B4
of European
Technical Assessment
ETA-21/0244

Table B4: Maximum processing time and minimum curing time

R-KEX-II			
Mortar temperature [°C]	Concrete (substrate) temperature [°C]	Maximum processing time [min.]	Minimum curing time¹⁾ [min.]
+5	+5	150	2880
+10	+10	120	1080
+20	+20	35	480
+25	+30	12	300

¹⁾ The minimum time from the end of the mixing to the time when the anchor may be torque or loaded (whichever is longer). Minimum mortar temperature for installation +5°C; maximum mortar temperature for installation +25°C. For wet condition and flooded holes the curing time must be doubled.

R-KEX-II	Annex B5 of European Technical Assessment ETA-21/0244
Intended use Maximum processing time and minimum curing time	

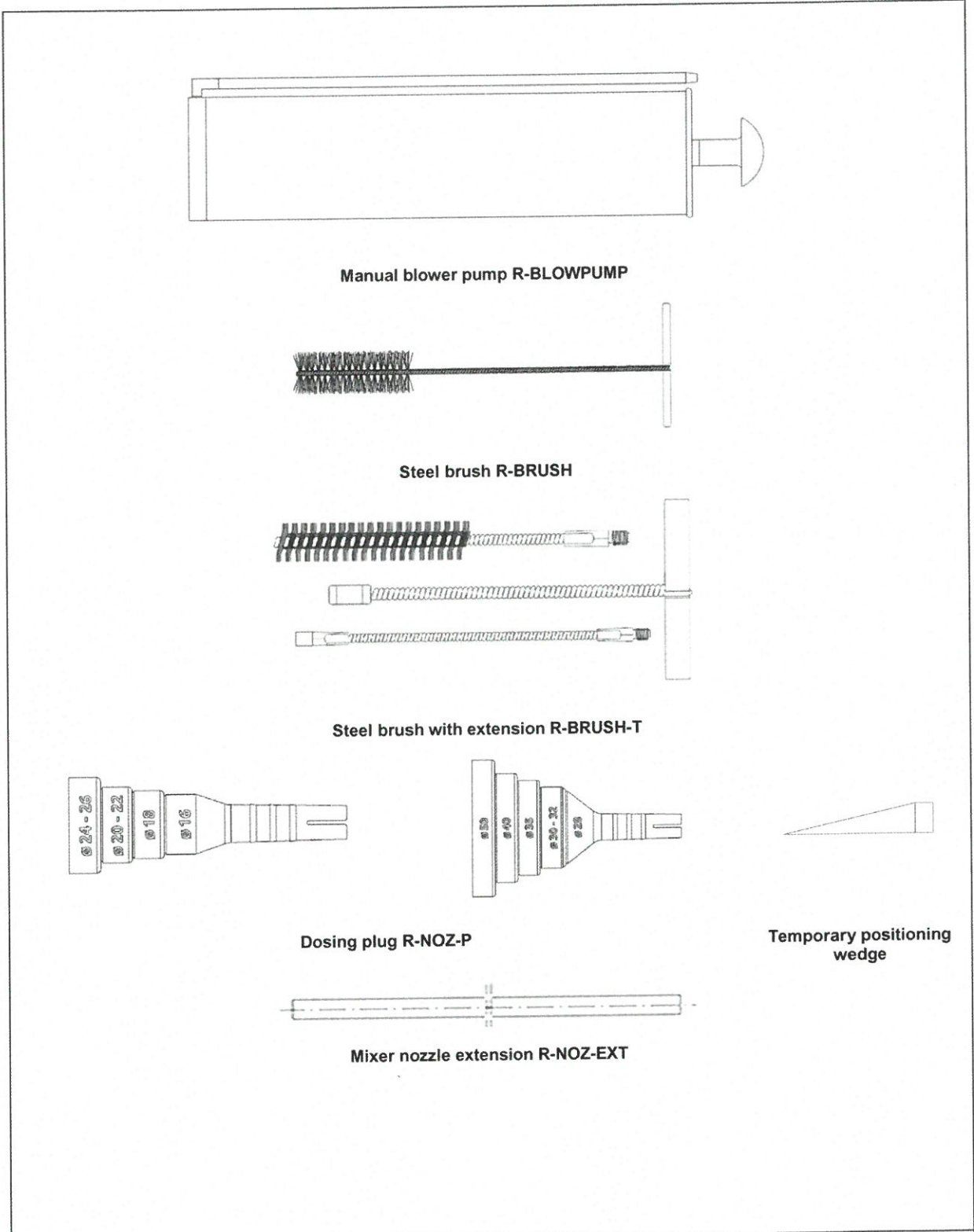

R-KEX-II	Annex B6 of European Technical Assessment ETA-21/0244
Intended use Tools (1)	

Dispenser	Cartridge size
 <p>Manual gun for side by side cartridges R-GUN-385-P</p>	385 ml
 <p>Manual gun for side by side cartridges R-GUN-600-P</p>	385, 600 ml
 <p>Cordless dispenser gun</p>  <p>Pneumatic dispenser gun</p>	385, 600 ml
 <p>Manual gun for side by side cartridges R-GUN-MULTI</p>	385, 600 ml
R-KEX-II	Annex B7 of European Technical Assessment ETA-21/0244
Intended use Tools (2)	

Table B5: Brush diameter for threaded rod

Threaded rod diameter			M8	M10	M12	M16	M20	M24	M30
d_b	Brush diameter	[mm]	12	14	16	20	26	30	37

Table B6: Brush diameter for rod with inner thread

Threaded rod diameter			M6/Ø10	M8/Ø12	M10/Ø16	M12/ Ø16	M16/Ø24
d_b	Brush diameter	[mm]	16	16	22	22	30

Table B7: Brush diameter for rebar

Rebar diameter			Ø8	Ø10	Ø12	Ø14	Ø16	Ø20	Ø25	Ø32
d_b	Brush diameter	[mm]	14	16	20	20	24	28	37	42



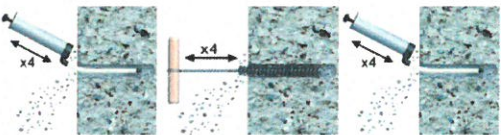
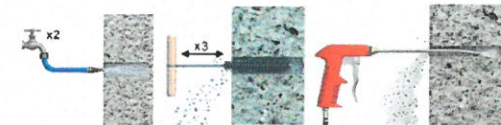

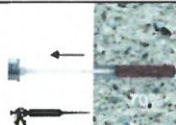
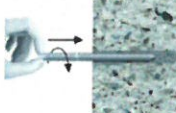
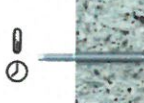

Table B8: Dosing plug diameter

Hole diameter [mm]	16	18	20	22	24	25	26	28	30	32	35	40	50
Dosing plug R-NOZ-P diameter	Ø16	Ø18	Ø20 to Ø22		Ø24 to Ø26		Ø28	Ø30 to 32		Ø35	Ø40	Ø50	





R-KEX-II

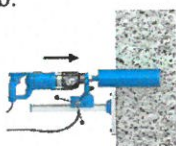
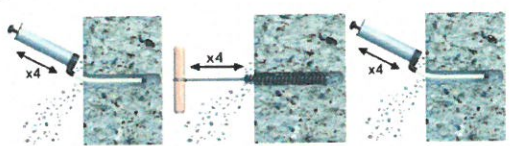
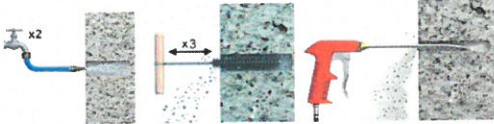

Intended use
Tools (3)

Annex B8
of European
Technical Assessment
ETA-21/0244

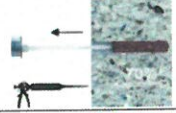
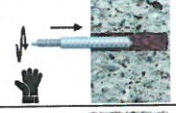
<p>1.</p> <p>a. </p> <p>b. </p>	<p>1. Hole drilling.</p> <p>a. Hammer drilling. Drill hole to the required diameter and depth using a rotary hammer drilling machine.</p> <p>b. Diamond core drilling. Drill hole to the required diameter and depth using a diamond core drilling machine and the corresponding core bit are used.</p>
<p>2.</p> <p>a. </p> <p>b. </p>	<p>2. Hole cleaning.</p> <p>a. Manual cleaning with brush and hand pump for hammer drilled hole:</p> <ul style="list-style-type: none"> - starting from the drill hole bottom blow the hole at least 4 times using the hand pump, - using the specified brush, mechanically brush out the hole at least 4 times, - starting from the drill hole bottom, blow at least 4 times with the hand pump. <p>b. Cleaning hole, diamond drilling, with compressed air:</p> <ul style="list-style-type: none"> - flush the hole from the bottom with water at least 2 times, - using the specified brush, mechanically brush out the hole at least 3 times, - starting from the drill hole bottom, blow at least 2 times with the hand pump.
<p>3. </p>	<p>3. Insert cartridge into dispenser and attach nozzle. Dispense to waste until even colour is obtained (min. 10 cm).</p>
<p>4. </p>	<p>4. Insert the mixing nozzle to the far end of the hole and inject mortar, slowly withdrawing the nozzle as the hole is filled to 2/3 of its depth.</p>
<p>5. </p>	<p>5. Immediately insert the threaded rod, slowly and with slight twisting motion. Remove any excess mortar around the hole before it sets.</p>
<p>6. </p>	<p>6. Leave the fixing undisturbed until the curing time elapses.</p>
<p>7. </p>	<p>7. Attach fixture and tighten the nut to the required torque. The installation torque cannot exceed $T_{inst,max}$.</p>

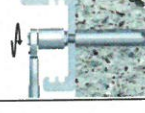
<p>R-KEX-II</p>	<p>Annex B9 of European Technical Assessment ETA-21/0244</p>
<p>Intended use Installation instruction – threaded rod</p>	

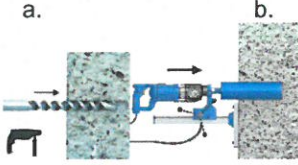
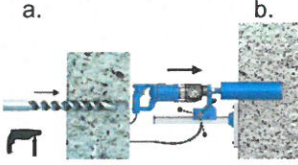
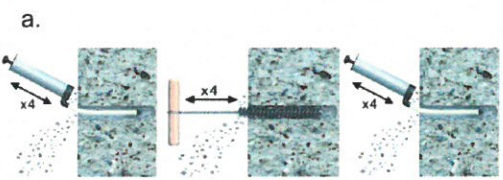
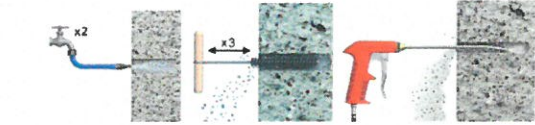
<p>1.</p> <p>a. </p> <p>b. </p>	<p>1. Hole drilling.</p> <p>a. Hammer drilling. Drill hole to the required diameter and depth using a rotary hammer drilling machine.</p> <p>b. Diamond core drilling. Drill hole to the required diameter and depth using a diamond core drilling machine and the corresponding core bit are used.</p>
<p>2.</p> <p>a. </p> <p>b. </p>	<p>2. Hole cleaning.</p> <p>a. Manual cleaning with brush and hand pump for hammer drilled hole:</p> <ul style="list-style-type: none"> - starting from the drill hole bottom blow the hole at least 4 times using the hand pump, - using the specified brush, mechanically brush out the hole at least 4 times, - starting from the drill hole bottom, blow at least 4 times with the hand pump. <p>b. Cleaning hole, diamond drilling, with compressed air:</p> <ul style="list-style-type: none"> - flush the hole from the bottom with water at least 2 times, - using the specified brush, mechanically brush out the hole at least 3 times, - starting from the drill hole bottom, blow at least 2 times with the hand pump.
<p>3. </p>	<p>3. Insert cartridge into dispenser and attach nozzle. Dispense to waste until even colour is obtained (min. 10 cm).</p>
<p>4. </p>	<p>4. Insert the mixing nozzle to the far end of the hole and inject mortar, slowly withdrawing the nozzle as the hole is filled to 2/3 of its depth.</p>
<p>5. </p>	<p>5. Immediately insert the rod with inner thread, slowly and with slight twisting motion. Remove any excess mortar around the hole before it sets.</p>
<p>6. </p>	<p>6. Leave the fixing undisturbed until the curing time elapses.</p>
<p>7. </p>	<p>7. Attach fixture and tighten the bolt to the required torque. The installation torque cannot exceed $T_{Inst,max}$.</p>
R-KEX-II	
<p>Intended use Installation instruction – anchor rod with inner thread</p>	<p>Annex B10 of European Technical Assessment ETA-21/0244</p>

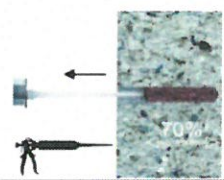
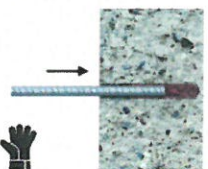
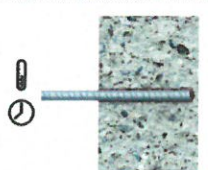
<p>1.</p> <p>a. </p> <p>b. </p>	<p>1. Hole drilling.</p> <p>a. Hammer drilling. Drill hole to the required diameter and depth using a rotary hammer drilling machine.</p> <p>b. Diamond core drilling. Drill hole to the required diameter and depth using a diamond core drilling machine and the corresponding core bit are used.</p>
<p>2.</p> <p>a. </p> <p>c. </p>	<p>2. Hole cleaning.</p> <p>a. Manual cleaning with brush and hand pump for hammer drilled hole:</p> <ul style="list-style-type: none"> - starting from the drill hole bottom blow the hole at least 4 times using the hand pump, - using the specified brush, mechanically brush out the hole at least 4 times, - starting from the drill hole bottom, blow at least 4 times with the hand pump. <p>b. Cleaning hole, diamond drilling, with compressed air:</p> <ul style="list-style-type: none"> - flush the hole from the bottom with water at least 2 times, - using the specified brush, mechanically brush out the hole at least 3 times, - starting from the drill hole bottom, blow at least 2 times with the hand pump.
<p>3. </p>	<p>3. Insert cartridge into dispenser and attach nozzle. Dispense to waste until even colour is obtained (min. 10 cm).</p>
<p>4. </p>	<p>4. Insert the mixing nozzle to the far end of the hole and inject mortar, slowly withdrawing the nozzle as the hole is filled to 2/3 of its depth.</p>
<p>5. </p>	<p>5. Immediately insert the rebar, slowly and with slight twisting motion. Remove any excess mortar around the hole before it sets.</p>
<p>6. </p>	<p>6. Leave the fixing undisturbed until the curing time elapses.</p>

<p>R-KEX-II</p>	<p>Annex B11 of European Technical Assessment ETA-21/0244</p>
<p>Intended use Installation instruction – rebar</p>	



	<ol style="list-style-type: none"> 1. Inject from the bottom of the hole. Inject the mortar about 2/3 of the hole depth. For best performance use extension and appropriately sized piston plug assembled on the mixer.
	<ol style="list-style-type: none"> 2. Drive the rebar immediately into the hole. Use temporary interlocking element e.g wedges.
	<ol style="list-style-type: none"> 3. Leave the fixing undisturbed until the curing time elapses. To avoid the slipping of the rebar during the open time of the product (due to the rebar own weight) use a temporary interlocking element.
<p>R-KEX-II</p>	<p>Annex B12 of European Technical Assessment ETA-21/0244</p>
<p>Intended use Installation instruction – rebar – overhead installation</p>	

Table C1-1: Characteristic resistance to tension load for threaded rod in uncracked concrete – static and quasi-static loads

Size			M8	M10	M12	M16	M20	M24	M30
Steel failure									
Steel, property class 5.8									
Characteristic resistance	$N_{Rk,s}$	[kN]	18	29	42	78	122	176	280
Partial safety factor ¹⁾	γ_{Ms}	[-]	1,50						
Steel, property class 8.8									
Characteristic resistance	$N_{Rk,s}$	[kN]	29	46	67	126	196	282	449
Partial safety factor ¹⁾	γ_{Ms}	[-]	1,50						
Steel, property class 10.9									
Characteristic resistance	$N_{Rk,s}$	[kN]	37	58	84	157	245	353	561
Partial safety factor ¹⁾	γ_{Ms}	[-]	1,40						
Steel, property class 12.9									
Characteristic resistance	$N_{Rk,s}$	[kN]	44	70	101	188	294	424	673
Partial safety factor ¹⁾	γ_{Ms}	[-]	1,40						
Stainless steel, property class A4-70									
Characteristic resistance	$N_{Rk,s}$	[kN]	26	41	59	110	171	247	393
Partial safety factor ¹⁾	γ_{Ms}	[-]	1,87						
Stainless steel, property class A4-80									
Characteristic resistance	$N_{Rk,s}$	[kN]	29	46	67	126	196	282	448
Partial safety factor ¹⁾	γ_{Ms}	[-]	1,60						
High corrosion resistant stainless steel, property class 70									
Characteristic resistance	$N_{Rk,s}$	[kN]	25	40	59	110	171	247	393
Partial safety factor ¹⁾	γ_{Ms}	[-]	1,87						
Combined pull-out and concrete cone failure in uncracked concrete C20/25 – hammer drilling, working life 50 years									
Temperature range I: 40°C/24°C	$\tau_{Rk,ucr,50}$	[N/mm ²]	17,0	16,0	17,0	15,0	15,0	13,0	12,0
Temperature range II: 80°C/50°C	$\tau_{Rk,ucr,50}$	[N/mm ²]	15,0	14,0	15,0	13,0	13,0	12,0	10,0
Combined pull-out and concrete cone failure in uncracked concrete C20/25 – diamond core drilling, working life 50 years									
Temperature range I: 40°C/24°C	$\tau_{Rk,ucr,50}$	[N/mm ²]	14,0	15,0	16,0	14,0	14,0	12,0	11,0
Temperature range II: 80°C/50°C	$\tau_{Rk,ucr,50}$	[N/mm ²]	12,0	14,0	14,0	13,0	13,0	11,0	10,0
Factors – working life 50 years									
Increasing factor	ψ_c	C30/37	1,04						
		C40/50	1,07						
		C50/60	1,09						
Sustained load factor for $\tau_{Rk,ucr,50}$ in uncracked concrete	$\psi_{sus,50}^0$	40°C/24°C	0,75						
		80°C/50°C	0,72						
Combined pull-out and concrete cone failure in uncracked concrete C20/25 – hammer drilling, working life 100 years									
Temperature range I: 40°C/24°C	$\tau_{Rk,ucr,100}$	[N/mm ²]	17,0	16,0	17,0	15,0	15,0	13,0	12,0
Temperature range II: 80°C/50°C	$\tau_{Rk,ucr,100}$	[N/mm ²]	15,0	14,0	15,0	13,0	13,0	12,0	10,0
Combined pull-out and concrete cone failure in uncracked concrete C20/25 – diamond core drilling, working life 100 years									
Temperature range I: 40°C/24°C	$\tau_{Rk,ucr,100}$	[N/mm ²]	14,0	15,0	16,0	14,0	14,0	12,0	11,0
Temperature range II: 80°C/50°C	$\tau_{Rk,ucr,100}$	[N/mm ²]	12,0	14,0	14,0	13,0	13,0	11,0	10,0
Factors – working life 100 years									
Increasing factor	ψ_c	C30/37	1,04						
		C40/50	1,07						
		C50/60	1,09						

¹⁾ In the absence of other national regulation

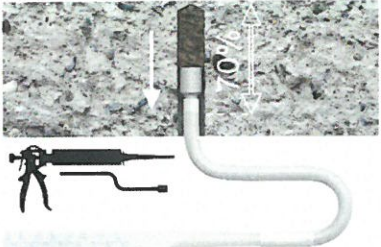
R-KEX-II

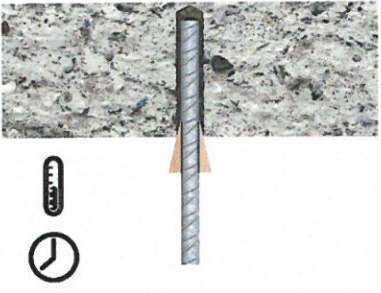
Performances
Characteristic resistance to tension loads
in uncracked concrete – threaded rod

Annex C1
of European
Technical Assessment
ETA-21/0244

Table C1-2: Characteristic resistance to tension load for threaded rod in uncracked concrete – static and quasi-static loads

Size	M8	M10	M12	M16	M20	M24	M30
Concrete cone failure in uncracked concrete							
Factor for uncracked concrete	$k_{ucr,N}$	[-]		11,0			
Edge distance	$c_{cr,N}$	[mm]		$1,5 \cdot h_{ef}$			
Spacing	$s_{cr,N}$	[mm]		$3,0 \cdot h_{ef}$			
Splitting failure							
Edge distance	$c_{cr,sp}$ for h_{min}	[mm]	$2,0 \cdot h_{ef}$			$1,5 \cdot h_{ef}$	
	$c_{cr,sp}$ for $h_{min} < h^{1)} < 2 \cdot h_{ef}$ ($c_{cr,sp}$ from linear interpolation)						
	$c_{cr,sp}$ for $h^{1)} \geq 2 \cdot h_{ef}$		$c_{cr,N}$				
Spacing	$s_{cr,sp}$	[mm]	$2,0 \cdot c_{cr,sp}$				
Installation safety factors for combined pull-out, concrete cone and splitting failure							
Installation safety factor for in use category I1	γ_{inst}	[-]	1,0				
Installation safety factor for in use category I2			1,2				

¹⁾h – concrete member thickness

R-KEX-II

Performances
Characteristic resistance to tension loads
in uncracked concrete – threaded rod

Annex C2
of European
Technical Assessment
ETA-21/0244

Table C2-1: Characteristic resistance to tension loads for threaded rod in cracked concrete – static and quasi-static loads

Size			M8	M10	M12	M16	M20	M24	M30
Steel failure									
Steel, property class 5.8									
Characteristic resistance	$N_{Rk,s}$	[kN]	18	29	42	78	122	176	280
Partial safety factor ¹⁾	γ_{Ms}	[-]	1,50						
Steel, property class 8.8									
Characteristic resistance	$N_{Rk,s}$	[kN]	29	46	67	125	196	282	448
Partial safety factor ¹⁾	γ_{Ms}	[-]	1,50						
Steel, property class 10.9									
Characteristic resistance	$N_{Rk,s}$	[kN]	36	58	84	157	245	353	561
Partial safety factor ¹⁾	γ_{Ms}	[-]	1,40						
Steel, property class 12.9									
Characteristic resistance	$N_{Rk,s}$	[kN]	43	69	101	188	294	423	673
Partial safety factor ¹⁾	γ_{Ms}	[-]	1,40						
Stainless steel, property class A4-70									
Characteristic resistance	$N_{Rk,s}$	[kN]	25	40	59	109	171	247	392
Partial safety factor ¹⁾	γ_{Ms}	[-]	1,87						
Stainless steel, property class A4-80									
Characteristic resistance	$N_{Rk,s}$	[kN]	29	46	67	125	196	282	448
Partial safety factor ¹⁾	γ_{Ms}	[-]	1,60						
High corrosion resistant stainless steel, property class 70									
Characteristic resistance	$N_{Rk,s}$	[kN]	25	40	59	109	171	247	392
Partial safety factor ¹⁾	γ_{Ms}	[-]	1,87						
Combined pull-out and concrete cone failure in cracked concrete C20/25 – hammer drilling, working life 50 years									
Temperature range I: 40°C/24°C	$\tau_{Rk,cr,50}$	[N/mm ²]	8,0	8,0	7,0	7,0	7,0	6,0	5,0
Temperature range II: 80°C/50°C	$\tau_{Rk,cr,50}$	[N/mm ²]	7,0	7,0	6,0	6,0	6,0	5,0	4,0
Combined pull-out and concrete cone failure in cracked concrete C20/25 – diamond core drilling, working life 50 years									
Temperature range I: 40°C/24°C	$\tau_{Rk,cr,50}$	[N/mm ²]	5,5	7,0	8,0	7,0	8,0	7,0	4,0
Temperature range II: 80°C/50°C	$\tau_{Rk,cr,50}$	[N/mm ²]	5,0	6,5	7,5	6,5	7,0	6,5	3,5
Factors – working life 50 years									
Increasing factor	ψ_c	C30/37	1,04						
		C40/50	1,07						
		C50/60	1,09						
Sustained load factor for $\tau_{Rk,ucr,50}$ in uncracked concrete	$\psi_{sus,50}^0$	40°C/24°C	0,75						
		80°C/50°C	0,72						
Combined pull-out and concrete cone failure in cracked concrete C20/25 – hammer drilling, working life 100 years									
Temperature range I: 40°C/24°C	$\tau_{Rk,cr,100}$	[N/mm ²]	8,0	8,0	6,5	7,0	7,0	6,0	5,0
Temperature range II: 80°C/50°C	$\tau_{Rk,cr,100}$	[N/mm ²]	6,5	7,0	6,0	6,0	6,0	5,0	4,0
Combined pull-out and concrete cone failure in cracked concrete C20/25 – diamond core drilling, working life 100 years									
Temperature range I: 40°C/24°C	$\tau_{Rk,cr,100}$	[N/mm ²]	5,5	7,0	8,0	7,0	7,0	6,0	4,0
Temperature range II: 80°C/50°C	$\tau_{Rk,cr,100}$	[N/mm ²]	5,0	6,5	7,0	6,0	6,5	5,0	3,5
Factors – working life 100 years									
Increasing factor	ψ_c	C30/37	1,00						
		C40/50	1,00						
		C50/60	1,00						

¹⁾ In the absence of other national regulation

R-KEX-II

Performances
Characteristic resistance to tension loads
in cracked concrete – threaded rod

Annex C3
of European
Technical Assessment
ETA-21/0244

Table C2-2: Characteristic resistance to tension load for threaded rod in cracked concrete – static and quasi-static loads

Size			M8	M10	M12	M16	M20	M24	M30	
Concrete cone failure in cracked concrete										
Factor for cracked concrete	$k_{cr,N}$	[-]	7,7							
Edge distance	$c_{cr,N}$	[mm]	$1,5 \cdot h_{ef}$							
Spacing	$s_{cr,N}$	[mm]	$3,0 \cdot h_{ef}$							
Splitting failure										
Edge distance	$c_{cr,sp}$ for h_{min}	[mm]	$2,0 \cdot h_{ef}$				$1,5 \cdot h_{ef}$			
	$c_{cr,sp}$ for $h_{min} < h^{1)} < 2 \cdot h_{ef}$ ($c_{cr,sp}$ from linear interpolation)									
	$c_{cr,sp}$ for $h^{1)} \geq 2 \cdot h_{ef}$		$c_{cr,N}$							
Spacing	$s_{cr,sp}$	[mm]	$2,0 \cdot c_{cr,sp}$							
Installation safety factors for combined pull-out, concrete cone and splitting failure										
Installation safety factors for in use category I1	γ_{inst}	[-]	1,0							
Installation safety factors for in use category I2			1,2							

¹⁾h – concrete member thickness

R-KEX-II

Performances
Characteristic resistance to tension loads
in cracked concrete – threaded rod

Annex C4
of European
Technical Assessment
ETA-21/0244

Table C3: Characteristic resistance to tension load for rod with inner thread in uncracked concrete – static and quasi-static loads

Size	M6 / Ø10	M8 / Ø12	M10 / Ø16	M12 / Ø16	M16 / Ø24		
Steel failure							
Steel, property class 5.8							
Characteristic resistance	$N_{Rk,s}$	[kN]	10	18	29	42	78
Partial safety factor ¹⁾	γ_{Ms}	[-]	1,50				
Steel, property class 8.8							
Characteristic resistance	$N_{Rk,s}$	[kN]	16	29	46	67	125
Partial safety factor ¹⁾	γ_{Ms}	[-]	1,50				
Stainless steel, property class A4-70							
Characteristic resistance	$N_{Rk,s}$	[kN]	14	25	40	59	109
Partial safety factor ¹⁾	γ_{Ms}	[-]	1,87				
Stainless steel, property class A4-80							
Characteristic resistance	$N_{Rk,s}$	[kN]	16	29	46	67	125
Partial safety factor ¹⁾	γ_{Ms}	[-]	1,60				
High corrosion resistant stainless steel, property class 70							
Characteristic resistance	$N_{Rk,s}$	[kN]	14	25	40	59	109
Partial safety factor ¹⁾	γ_{Ms}	[-]	1,87				
Combined pull-out and concrete cone failure in uncracked concrete C20/25 – hammer drilling							
Temperature range I: 40°C/24°C	$\tau_{Rk,ucr,50}$	[N/mm ²]	8,0	12,0	12,0	11,0	10,0
Temperature range II: 80°C/50°C	$\tau_{Rk,ucr,50}$	[N/mm ²]	7,5	11,0	11,0	10,0	9,0
Increasing factor	ψ_c	C30/37	1,04				
		C40/50	1,07				
		C50/60	1,09				
Sustained load factor for $\tau_{Rk,ucr,50}$ in uncracked concrete	$\psi^0_{sus,50}$	40°C/24°C	0,75				
		80°C/50°C	0,72				
Combined pull-out and concrete cone failure in uncracked concrete C20/25 – hammer drilling, working life 100 years							
Temperature range I: 40°C/24°C	$\tau_{Rk,ucr,100}$	[N/mm ²]	8,0	12,0	12,0	11,0	10,0
Temperature range II: 80°C/50°C	$\tau_{Rk,ucr,100}$	[N/mm ²]	7,5	11,0	10,0	10,0	9,0
Factors – working life 100 years							
Increasing factor	ψ_c	C30/37	1,04				
		C40/50	1,07				
		C50/60	1,09				
Resistance to concrete cone failure in uncracked concrete – hammer drilling							
Factor for uncracked concrete	$k_{ucr,N}$	[-]	11,0				
Edge distance	$c_{cr,N}$	[mm]	$1,5 \cdot h_{ef}$				
Spacing	$s_{cr,N}$	[mm]	$3,0 \cdot h_{ef}$				
Splitting failure							
Edge distance	$c_{cr,sp}$ for h_{min}	[mm]	$2,0 \cdot h_{ef}$			$1,5 \cdot h_{ef}$	
	$c_{cr,sp}$ for $h_{min} < h^2 < 2 \cdot h_{ef}$ ($c_{cr,sp}$ from linear interpolation)						
	$c_{cr,sp}$ for $h^2 \geq 2 \cdot h_{ef}$		$c_{cr,N}$				
Spacing	$s_{cr,sp}$	[mm]	$2,0 \cdot c_{cr,sp}$				
Installation safety factors for combined pull-out, concrete cone and splitting failure							
Installation safety factors for use category I1	γ_{inst}	[-]	1,2				
Installation safety factors for use category I2			1,2				

¹⁾ In the absence of other national regulation

²⁾ h – concrete member thickness

R-KEX-II

Performances

Characteristic resistance to tension loads in uncracked concrete – rod with inner thread

Annex C5

of European Technical Assessment
ETA-21/0244

Table C4: Characteristic resistance to tension load for rebar in uncracked concrete – static and quasi-static loads

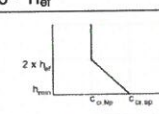
Size			Ø8	Ø10	Ø12	Ø14	Ø16	Ø20	Ø25	Ø32
Steel failure										
Characteristic resistance	$N_{Rk,s}$	[kN]	$A_s^{3)} \cdot f_{uk}$							
Partial safety factor ¹⁾	γ_{Ms}	[-]	1,40							
Combined pull-out and concrete cone failure in uncracked concrete C20/25 – hammer drilling, working life 50 years										
Temperature range I: 40°C/24°C	$\tau_{Rk,ucr,50}$	[N/mm ²]	11,0	12,0	12,0	10,0	12,0	12,0	9,5	8,5
Temperature range II: 80°C/50°C	$\tau_{Rk,ucr,50}$	[N/mm ²]	10,0	11,0	11,0	9,0	11,0	11,0	8,5	7,5
Combined pull-out and concrete cone failure in uncracked concrete C20/25 – diamond core drilling, working life 50 years										
Temperature range I: 40°C/24°C	$\tau_{Rk,ucr,50}$	[N/mm ²]	9,5	11,0	10,0	10,0	10,5	11,0	9,0	8,0
Temperature range II: 80°C/50°C	$\tau_{Rk,ucr,50}$	[N/mm ²]	8,5	10,0	9,0	9,0	9,0	10,0	8,0	7,0
Factors – working life 50 years										
Increasing factor	ψ_c	C30/37	1,04							
		C40/50	1,07							
		C50/60	1,09							
Sustained load factor for $\tau_{Rk,ucr,50}$ in uncracked concrete	$\psi_{sus,50}^0$	40°C/24°C	0,75							
		80°C/50°C	0,72							
Combined pull-out and concrete cone failure in uncracked concrete C20/25 – hammer drilling, working life 100 years										
Temperature range I: 40°C/24°C	$\tau_{Rk,ucr,100}$	[N/mm ²]	11,0	12,0	12,0	10,0	12,0	12,0	9,5	8,5
Temperature range II: 80°C/50°C	$\tau_{Rk,ucr,100}$	[N/mm ²]	10,0	11,0	11,0	9,0	11,0	11,0	8,5	7,5
Combined pull-out and concrete cone failure in uncracked concrete C20/25 – diamond core drilling, working life 100 years										
Temperature range I: 40°C/24°C	$\tau_{Rk,ucr,100}$	[N/mm ²]	9,5	11,0	10,0	10,0	10,5	11,0	9,0	8,0
Temperature range II: 80°C/50°C	$\tau_{Rk,ucr,100}$	[N/mm ²]	8,5	10,0	9,0	9,0	9,0	10,0	8,0	7,0
Factors – working life 100 years										
Increasing factor	ψ_c	C30/37	1,04							
		C40/50	1,07							
		C50/60	1,09							
Concrete cone failure in uncracked concrete										
Factor for uncracked concrete	$k_{ucr,N}$	[-]	11,0							
Edge distance	$c_{cr,N}$	[mm]	$1,5 \cdot h_{ef}$							
Spacing	$s_{cr,N}$	[mm]	$3,0 \cdot h_{ef}$							
Splitting failure										
Edge distance	$c_{cr,sp}$ for h_{min}	[mm]	$2,0 \cdot h_{ef}$							$1,5 \cdot h_{ef}$
	$c_{cr,sp}$ for $h_{min} < h^2) < 2 \cdot h_{ef}$ ($c_{cr,sp}$ from linear interpolation)									
	$c_{cr,sp}$ for $h^2) \geq 2 \cdot h_{ef}$		$c_{cr,N}$							
Spacing	$s_{cr,sp}$	[mm]	$2,0 \cdot c_{cr,sp}$							
Installation safety factors for combined pull-out, concrete cone and splitting failure										
Installation safety factors for use category I1	γ_{inst}	[-]	1,2							
Installation safety factors for use category I2			1,2							

¹⁾ In the absence of other national regulation

²⁾ h – concrete member thickness

³⁾ Stressed cross section of the steel

R-KEX-II

Performances
Characteristic resistance to tension loads
in uncracked concrete – rebar

Annex C6
of European
Technical Assessment
ETA-21/0244

Table C5: Characteristic resistance to tension loads for rebar in cracked concrete – static and quasi-static loads

Size			Ø8	Ø10	Ø12	Ø14	Ø16	Ø20	Ø25	Ø32
Steel failure										
Characteristic resistance	$N_{Rk,s}$	[kN]	$A_s^{3)} \cdot f_{uk}$							
Partial safety factor ¹⁾	γ_{Ms}	[-]	1,40							
Combined pull-out and concrete cone failure in cracked concrete C20/25 – hammer drilling, working life 50 years										
Temperature range I: 40°C/24°C	$\tau_{Rk,cr,50}$	[N/mm ²]	5,5	5,0	5,5	5,5	5,0	5,0	5,4	4,0
Temperature range II: 80°C/50°C	$\tau_{Rk,cr,50}$	[N/mm ²]	5,0	4,5	5,0	5,0	4,5	4,5	5,0	3,0
Combined pull-out and concrete cone failure in cracked concrete C20/25 – diamond core drilling, working life 50 years										
Temperature range I: 40°C/24°C	$\tau_{Rk,cr,50}$	[N/mm ²]	5,5	5,5	6,0	6,0	5,0	5,5	4,5	4,0
Temperature range II: 80°C/50°C	$\tau_{Rk,cr,50}$	[N/mm ²]	5,0	5,0	5,5	5,5	4,5	5,0	4,0	4,0
Factors – working life 50 years										
Increasing factor	ψ_c	C30/37	1,04							
		C40/50	1,07							
		C50/60	1,09							
Sustained load factor for $\tau_{Rk,ucr,50}$ in uncracked concrete	$\psi_{sus,50}^0$	40°C/24°C	0,75							
		80°C/50°C	0,72							
Combined pull-out and concrete cone failure in cracked concrete C20/25 – hammer drilling, working life 100 years										
Temperature range I: 40°C/24°C	$\tau_{Rk,cr,100}$	[N/mm ²]	5,5	5,0	5,5	5,5	5,0	5,0	5,4	4,0
Temperature range II: 80°C/50°C	$\tau_{Rk,cr,100}$	[N/mm ²]	5,0	4,5	5,0	5,0	4,5	4,5	5,0	3,0
Combined pull-out and concrete cone failure in cracked concrete C20/25 – diamond core drilling, working life 100 years										
Temperature range I: 40°C/24°C	$\tau_{Rk,cr,100}$	[N/mm ²]	5,5	5,5	6,0	6,0	5,0	5,0	4,5	4,0
Temperature range II: 80°C/50°C	$\tau_{Rk,cr,100}$	[N/mm ²]	5,0	5,0	5,5	5,5	4,5	4,5	4,0	4,0
Factors – working life 100 years										
Increasing factor	ψ_c	C30/37	1,04							
		C40/50	1,07							
		C50/60	1,09							
Concrete cone failure in cracked concrete										
Factor for cracked concrete	$k_{cr,N}$	[-]	7,7							
Edge distance	$c_{cr,N}$	[mm]	$1,5 \cdot h_{ef}$							
Spacing	$s_{cr,N}$	[mm]	$3,0 \cdot h_{ef}$							
Splitting failure										
Edge distance	$c_{cr,sp}$ for h_{min}	[mm]	$2,0 \cdot h_{ef}$							$1,5 \cdot h_{ef}$
	$c_{cr,sp}$ for $h_{min} < h^2) < 2 \cdot h_{ef}$ ($c_{cr,sp}$ from linear interpolation)									
	$c_{cr,sp}$ for $h^2) \geq 2 \cdot h_{ef}$		$c_{cr,N}$							
Spacing	$s_{cr,sp}$	[mm]	$2,0 \cdot c_{cr,sp}$							
Partial safety factor for combined pull-out, concrete cone and splitting failure										
Installation safety factors for in use category I1	γ_{inst}	[-]	1,2							
Installation safety factors for in use category I2			1,2							

¹⁾ In the absence of other national regulation

²⁾ h – concrete member thickness

³⁾ Stressed cross section of the steel element

R-KEX-II

Performances
Characteristic resistance to tension loads
in cracked concrete – rebar

Annex C7
of European
Technical Assessment
ETA-21/0244

Table C6: Characteristic resistance to shear loads for threaded rod – steel failure without lever arm

Size			M8	M10	M12	M16	M20	M24	M30
Steel, property class 5.8									
Characteristic resistance	$V_{Rk,s}^0$	[kN]	11	17	25	47	73	106	168
Factor considering ductility	k_7	[-]				1,0			
Partial safety factor ¹⁾	γ_{Ms}	[-]				1,25			
Steel, property class 8.8									
Characteristic resistance	$V_{Rk,s}^0$	[kN]	15	23	34	63	98	141	224
Factor considering ductility	k_7	[-]				1,0			
Partial safety factor ¹⁾	γ_{Ms}	[-]				1,25			
Steel, property class 10.9									
Characteristic resistance	$V_{Rk,s}^0$	[kN]	18	29	42	78	122	176	280
Factor considering ductility	k_7	[-]				1,0			
Partial safety factor ¹⁾	γ_{Ms}	[-]				1,50			
Steel, property class 12.9									
Characteristic resistance	$V_{Rk,s}^0$	[kN]	22	35	51	94	147	212	336
Factor considering ductility	k_7	[-]				1,0			
Partial safety factor ¹⁾	γ_{Ms}	[-]				1,50			
Stainless steel, property class A4-70									
Characteristic resistance	$V_{Rk,s}^0$	[kN]	13	20	29	55	86	124	196
Factor considering ductility	k_7	[-]				1,0			
Partial safety factor ¹⁾	γ_{Ms}	[-]				1,56			
Stainless steel, property class A4-80									
Characteristic resistance	$V_{Rk,s}^0$	[kN]	15	23	34	63	98	141	224
Factor considering ductility	k_7	[-]				1,0			
Partial safety factor ¹⁾	γ_{Ms}	[-]				1,33			
High corrosion resistant stainless steel, property class 70									
Characteristic resistance	$V_{Rk,s}^0$	[kN]	13	20	29	55	86	124	196
Factor considering ductility	k_7	[-]				1,0			
Partial safety factor ¹⁾	γ_{Ms}	[-]				1,56			

¹⁾ In the absence of other national regulation

R-KEX-II

Performances

Characteristic resistance to shear loads
in cracked and uncracked concrete – threaded rod

Annex C8

of European
Technical Assessment
ETA-21/0244

Table C7: Characteristic resistance to shear loads for threaded rod – steel failure with lever arm

Size			M8	M10	M12	M16	M20	M24	M30
Steel, property class 5.8									
Characteristic resistance	$M_{Rk,s}^0$	[Nm]	19	37	65	166	324	561	1124
Partial safety factor ¹⁾	γ_{Ms}	[-]	1,25						
Steel, property class 8.8									
Characteristic resistance	$M_{Rk,s}^0$	[Nm]	30	60	105	266	519	898	1799
Partial safety factor ¹⁾	γ_{Ms}	[-]	1,25						
Steel, property class 10.9									
Characteristic resistance	$M_{Rk,s}^0$	[Nm]	37	75	131	333	649	1123	2249
Partial safety factor ¹⁾	γ_{Ms}	[-]	1,50						
Steel, property class 12.9									
Characteristic resistance	$M_{Rk,s}^0$	[Nm]	45	90	157	400	779	1347	2698
Partial safety factor ¹⁾	γ_{Ms}	[-]	1,50						
Stainless steel, property class A4-70									
Characteristic resistance	$M_{Rk,s}^0$	[Nm]	26	52	92	233	454	786	1574
Partial safety factor ¹⁾	γ_{Ms}	[-]	1,56						
Stainless steel, property class A4-80									
Characteristic resistance	$M_{Rk,s}^0$	[Nm]	30	60	105	266	519	898	1799
Partial safety factor ¹⁾	γ_{Ms}	[-]	1,33						
High corrosion resistant stainless steel, property class 70									
Characteristic resistance	$M_{Rk,s}^0$	[Nm]	26	52	92	233	454	786	1574
Partial safety factor ¹⁾	γ_{Ms}	[-]	1,56						

¹⁾ In the absence of other national regulation

Table C8: Characteristic resistance to shear loads – pry out and concrete edge failure for threaded rod

Size			M8	M10	M12	M16	M20	M24	M30
Pry out failure									
Factor	k_8	[-]	2						
Concrete edge failure									
Outside diameter of anchor	d_{nom}	[mm]	8	10	12	16	20	24	30
Effective length of anchor under shear loading	l_f	[mm]	min (h_{ef} ; $12d_{nom}$)						min (h_{ef} ; $8d_{nom}$)

R-KEX-II

Performances
Characteristic resistance to shear loads
in cracked and uncracked concrete – threaded rod

Annex C9
of European
Technical Assessment
ETA-21/0244

Table C9: Characteristic resistance to shear loads for rod with inner thread – steel failure without lever arm

Size			M6/ Ø10	M8/ Ø12	M10/ Ø16	M12/ Ø16	M16/ Ø24
Steel, property class 5.8							
Characteristic resistance	$V_{Rk,s}^0$	[kN]	6,0	11,0	17,0	25,0	47,0
Factor considering ductility	k_7	[-]			1,0		
Partial safety factor ¹⁾	γ_{Ms}	[-]			1,25		
Steel, property class 8.8							
Characteristic resistance	$V_{Rk,s}^0$	[kN]	8,0	14,6	23,2	33,7	62,8
Factor considering ductility	k_7	[-]			1,0		
Partial safety factor ¹⁾	γ_{Ms}	[-]			1,25		
Stainless steel, property class A4-70							
Characteristic resistance	$V_{Rk,s}^0$	[kN]	7,0	12,8	20,3	29,5	55,0
Factor considering ductility	k_7	[-]			1,0		
Partial safety factor ¹⁾	γ_{Ms}	[-]			1,56		
Stainless steel, property class A4-80							
Characteristic resistance	$V_{Rk,s}^0$	[kN]	8,0	14,6	23,2	33,7	62,8
Factor considering ductility	k_7	[-]			1,0		
Partial safety factor ¹⁾	γ_{Ms}	[-]			1,33		
High corrosion resistant stainless steel, property class 70							
Characteristic resistance	$V_{Rk,s}^0$	[kN]	7,0	12,8	20,3	29,5	55,0
Factor considering ductility	k_7	[-]			1,0		
Partial safety factor ¹⁾	γ_{Ms}	[-]			1,56		

¹⁾ In the absence of other national regulation

Table C10: Characteristic resistance to shear loads for rod with inner thread – steel failure with lever arm

Size			M6/ Ø10	M8/ Ø12	M10/ Ø16	M12/ Ø16	M16/ Ø24
Steel, property class 5.8							
Characteristic resistance	$M_{Rk,s}^0$	[Nm]	7,6	18,7	37,4	65,5	166,5
Partial safety factor ¹⁾	γ_{Ms}	[-]			1,25		
Steel, property class 8.8							
Characteristic resistance	$M_{Rk,s}^0$	[Nm]	12,2	30,0	59,8	104,8	266,4
Partial safety factor ¹⁾	γ_{Ms}	[-]			1,25		
Stainless steel, property class A4-70							
Characteristic resistance	$M_{Rk,s}^0$	[Nm]	10,7	26,2	52,3	91,7	233,1
Partial safety factor ¹⁾	γ_{Ms}	[-]			1,56		
Stainless steel, property class A4-80							
Characteristic resistance	$M_{Rk,s}^0$	[Nm]	12,2	30,0	59,8	104,8	266,4
Partial safety factor ¹⁾	γ_{Ms}	[-]			1,33		
High corrosion resistant stainless steel, property class 70							
Characteristic resistance	$M_{Rk,s}^0$	[Nm]	10,7	26,2	52,3	91,7	233,1
Partial safety factor ¹⁾	γ_{Ms}	[-]			1,56		

¹⁾ In the absence of other national regulation

Table C11: Characteristic resistance to shear loads – pry out and concrete edge failure for rod with inner thread

Size			M6/ Ø10	M8/ Ø12	M10/ Ø16	M12/ Ø16	M16/ Ø24	
Pry out failure								
Factor	k_8	[-]			2			
Concrete edge failure								
Outside diameter of anchor	d_{nom}	[mm]	10	12	16	16	24	
Effective length of anchor under shear loading	l_f	[mm]	min (h_{ef} ; $12d_{nom}$)					

R-KEX-II

Performances

Characteristic resistance to shear loads
in cracked and uncracked concrete – rod with inner thread

Annex C10

of European
Technical Assessment
ETA-21/0244

Table C12: Characteristic resistance to shear loads for rebar – steel failure without lever arm

Size	Ø8	Ø10	Ø12	Ø14	Ø16	Ø20	Ø25	Ø32
Rebar								
Characteristic resistance	$V_{Rk,s}^0$		[kN]	$0,5 \cdot A_s^{2)} \cdot f_{uk}$				
Factor considering ductility	k_7		[-]	1,0				
Partial safety factor ¹⁾	γ_{Ms}		[-]	1,5				

¹⁾ In the absence of other national regulation

²⁾ Stressed cross section of the steel element

Table C13: Characteristic resistance to shear loads for rebar – steel failure with lever arm

Size	Ø8	Ø10	Ø12	Ø14	Ø16	Ø20	Ø25	Ø32
Rebar								
Characteristic resistance	$M_{Rk,s}^0$		[Nm]	$1,2 \cdot W_{el}^{2)} \cdot f_{uk}$				
Partial safety factor ¹⁾	γ_{Ms}		[-]	1,5				

¹⁾ In the absence of other national regulation

²⁾ Elastic section modulus calculated from the stressed cross section of steel element

Table C14: Characteristic resistance to shear loads – pry out and concrete edge failure for rebar

Size	Ø8	Ø10	Ø12	Ø14	Ø16	Ø20	Ø25	Ø32		
Pry out failure										
Factor	k_8	[-]	2							
Concrete edge failure										
Outside diameter of anchor	d_{nom}	[mm]	8	10	12	14	16	20	25	32
Effective length of anchor under shear loading	l_f	[mm]	min (h_{ef} ; 12d _{nom})					min (h_{ef} ; 8d _{nom})		

R-KEX-II

Performances
 Characteristic resistance to shear loads
 in cracked and uncracked concrete – rebar

Annex C11
 of European
 Technical Assessment
 ETA-21/0244

Table C15: Displacement under tension loads – threaded rod

Size			M8	M10	M12	M16	M20	M24	M30
Characteristic displacement in uncracked concrete C20/25 to C50/60 under tension loads									
Displacement ¹⁾	δ_{N0}	[mm]	0,33	0,40	0,41	0,47	0,52	0,56	0,70
	$\delta_{N\infty}$	[mm]	0,75	0,75	0,75	0,75	0,75	0,75	0,75
Characteristic displacement in cracked concrete C20/25 to C50/60 under tension loads									
Displacement ¹⁾	δ_{N0}	[mm]	0,20	0,20	0,24	0,28	0,39	0,44	0,46
	$\delta_{N\infty}$	[mm]	3,0	3,0	2,5	2,6	2,5	2,4	3,0
¹⁾ These values are suitable for each temperature range and categories specified in Annex B1 Calculation of the displacement: $\delta_{N0} = \delta_{N0}\text{-factor} \cdot N$; $\delta_N = \delta_{N\infty}\text{-factor} \cdot N$; (N – applied tension load)									

Table C16: Displacement under shear loads – threaded rod

Size			M8	M10	M12	M16	M20	M24	M30
Characteristic displacement in cracked and uncracked concrete C20/25 to C50/60 under shear loads									
Displacement ¹⁾	δ_{V0}	[mm]	2,5	2,5	2,5	2,5	2,5	2,5	2,5
	$\delta_{V\infty}$	[mm]	3,7	3,7	3,7	3,7	3,7	3,7	3,7
¹⁾ These values are suitable for each temperature range and categories specified in Annex B1 Calculation of the displacement: $\delta_{N0} = \delta_{N0}\text{-factor} \cdot V$; $\delta_N = \delta_{N\infty}\text{-factor} \cdot V$; (V – applied shear load)									

Table C17: Displacement under tension loads – rod with inner thread

Size			M6/Ø10	M8/Ø12	M10/Ø16	M12/Ø16	M16/Ø24
Characteristic displacement in uncracked concrete C20/25 to C50/60 under tension loads							
Displacement ¹⁾	δ_{N0}	[mm]	0,25	0,25	0,26	0,32	0,37
	$\delta_{N\infty}$	[mm]	0,75	0,75	0,75	0,75	0,75
¹⁾ These values are suitable for each temperature range and categories specified in Annex B1 Calculation of the displacement: $\delta_{N0} = \delta_{N0}\text{-factor} \cdot N$; $\delta_N = \delta_{N\infty}\text{-factor} \cdot N$; (N – applied tension load)							

Table C18: Displacement under shear loads – rod with inner thread

Size			M6/Ø10	M8/Ø12	M10/Ø16	M12/ Ø16	M16/Ø24
Characteristic displacement in uncracked concrete C20/25 to C50/60 under shear loads							
Displacement ¹⁾	δ_{V0}	[mm]	2,5	2,5	2,5	2,5	2,5
	$\delta_{V\infty}$	[mm]	3,7	3,7	3,7	3,7	3,7
¹⁾ These values are suitable for each temperature range and categories specified in Annex B1 Calculation of the displacement: $\delta_{N0} = \delta_{N0}\text{-factor} \cdot V$; $\delta_N = \delta_{N\infty}\text{-factor} \cdot V$; (V – applied shear load)							

R-KEX-II**Performances**

Displacement under service loads: tension and shear loads – threaded rod and rod with inner thread

Annex C12
 of European
 Technical Assessment
 ETA-21/0244

Table C19: Displacement under tension loads – rebar

Size			Ø8	Ø10	Ø12	Ø14	Ø16	Ø20	Ø25	Ø32
Characteristic displacement in uncracked concrete C20/25 to C50/60 under tension loads										
Displacement ¹⁾	δ_{N0}	[mm]	0,25	0,25	0,32	0,37	0,43	0,45	0,48	0,53
	$\delta_{N\infty}$	[mm]	0,75	0,75	0,75	0,75	0,75	0,75	0,75	0,75
Characteristic displacement in cracked concrete C20/25 to C50/60 under tension loads										
Displacement	δ_{N0}	[mm]	0,2	0,2	0,24	0,30	0,31	0,34	0,38	0,40
	$\delta_{N\infty}$	[mm]	3,0	3,0	3,0	3,0	3,0	3,0	3,0	3,0
¹⁾ These values are suitable for each temperature range and categories specified in Annex B1. Calculation of the displacement: $\delta_{N0} = \delta_{N0\text{-factor}} \cdot N$; $\delta_N = \delta_{N\infty\text{-factor}} \cdot N$; (N – applied tension load)										

Table C20: Displacement under shear loads – rebar

Size			Ø8	Ø10	Ø12	Ø14	Ø16	Ø20	Ø25	Ø32
Characteristic displacement in cracked and uncracked concrete C20/25 to C50/60 under shear loads										
Displacement ¹⁾	δ_{V0}	[mm]	2,5	2,5	2,5	2,5	2,5	2,5	2,5	2,5
	$\delta_{V\infty}$	[mm]	3,7	3,7	3,7	3,7	3,7	3,7	3,7	3,7
¹⁾ These values are suitable for each temperature range and categories specified in Annex B1. Calculation of the displacement: $\delta_{N0} = \delta_{N0\text{-factor}} \cdot V$; $\delta_N = \delta_{N\infty\text{-factor}} \cdot V$; (V – applied shear load)										

R-KEX-II

Performances

Displacement under service loads: tension and shear loads – rebar

Annex C13
of European
Technical Assessment
ETA-21/0244

Table C21: Characteristic resistance to tension load – threaded rod under seismic performance category C1

Size			M8	M10	M12	M16	M20	M24	M30
Steel failure									
Steel, property class 5.8									
Characteristic resistance	$N_{Rk,s,C1}$	[kN]	18	29	42	78	122	176	280
Partial safety factor ¹⁾	$\gamma_{Ms,C1}$	[-]	1,50						
Steel, property class 8.8									
Characteristic resistance	$N_{Rk,s,C1}$	[kN]	29	46	67	125	196	282	448
Partial safety factor ¹⁾	$\gamma_{Ms,C1}$	[-]	1,50						
Steel, property class 10.9									
Characteristic resistance	$N_{Rk,s,C1}$	[kN]	36	58	84	157	245	353	561
Partial safety factor ¹⁾	$\gamma_{Ms,C1}$	[-]	1,4						
Steel, property class 12.9									
Characteristic resistance	$N_{Rk,s,C1}$	[kN]	43	69	101	188	294	423	673
Partial safety factor ¹⁾	$\gamma_{Ms,C1}$	[-]	1,4						
Stainless steel, property class A4-70									
Characteristic resistance	$N_{Rk,s,C1}$	[kN]	25	40	59	109	171	247	392
Partial safety factor ¹⁾	$\gamma_{Ms,C1}$	[-]	1,87						
Stainless steel, property class A4-80									
Characteristic resistance	$N_{Rk,s,C1}$	[kN]	29	46	67	125	196	282	448
Partial safety factor ¹⁾	$\gamma_{Ms,C1}$	[-]	1,60						
High corrosion resistant stainless steel, property class 70									
Characteristic resistance	$N_{Rk,s,C1}$	[kN]	25	40	59	109	171	247	392
Partial safety factor ¹⁾	$\gamma_{Ms,C1}$	[-]	1,87						
Combined pull-out and concrete cone failure, working life 50 years									
Temperature range I: 40°C/24°C	$\tau_{Rk,C1}$	[N/mm ²]	6,0	7,0	6,5	7,0	6,0	5,5	4,0
Temperature range II: 80°C/50°C	$\tau_{Rk,C1}$	[N/mm ²]	5,0	6,5	5,5	6,0	5,5	5,0	3,5
Combined pull-out and concrete cone failure, working life 100 years									
Temperature range I: 40°C/24°C	$\tau_{Rk,C1}$	[N/mm ²]	6,0	7,0	6,0	6,5	6,0	5,5	4,0
Temperature range II: 80°C/50°C	$\tau_{Rk,C1}$	[N/mm ²]	5,0	6,0	5,5	6,0	5,5	5,0	3,5

Note: Design method according to TR 045

¹⁾ In the absence of other national regulation**Table C22: Characteristic resistance to tension load – rebar under seismic performance category C1**

Size			Ø8	Ø10	Ø12	Ø14	Ø16	Ø20	Ø25	Ø32
Steel failure										
Characteristic resistance	$N_{Rk,s,C1}$	[kN]	$A_s^{2)} \cdot f_{uk}$							
Partial safety factor ¹⁾	$\gamma_{Ms,C1}$	[-]	1,40							
Combined pull-out and concrete cone failure, working life 50 years										
Temperature range I: 40°C/24°C	$\tau_{Rk,C1}$	[N/mm ²]	4,0	4,5	5,0	5,0	5,0	5,0	5,0	3,0
Temperature range II: 80°C/50°C	$\tau_{Rk,C1}$	[N/mm ²]	3,5	4,0	4,5	4,5	4,5	4,5	4,5	2,5
Combined pull-out and concrete cone failure, working life 100 years										
Temperature range I: 40°C/24°C	$\tau_{Rk,C1}$	[N/mm ²]	3,5	4,5	5,0	5,0	5,0	3,5	5,0	3,0
Temperature range II: 80°C/50°C	$\tau_{Rk,C1}$	[N/mm ²]	3,5	4,0	4,5	4,5	4,5	4,0	4,5	2,5

Note: Design method according to TR 045

¹⁾ In the absence of other national regulation²⁾ Stressed cross section of the steel element**R-KEX-II****Performances**Characteristic resistance to tension loads for threaded rod and rebar
for seismic performance category C1**Annex C14**
of European
Technical Assessment
ETA-21/0244

Table C23: Characteristic resistance to shear loads – threaded rod under seismic performance category C1 – steel failure without lever arm

Size			M8	M10	M12	M16	M20	M24	M30
Steel failure with threaded rod grade 5.8									
Characteristic resistance	$V_{Rk,s,C1}$	[kN]	7,7	11,9	17,5	32,9	51,1	74,2	117,6
Partial safety factor ¹⁾	$\gamma_{Ms, C1}$	[-]	1,25						
Steel failure with threaded rod grade 8.8									
Characteristic resistance	$V_{Rk,s,C1}$	[kN]	10,2	16,1	23,5	44,1	68,6	98,7	156,8
Partial safety factor ¹⁾	$\gamma_{Ms, C1}$	[-]	1,25						
Steel failure with threaded rod grade 10.9									
Characteristic resistance	$V_{Rk,s,C1}$	[kN]	12,6	20,3	29,4	54,6	85,4	123,2	196
Partial safety factor ¹⁾	$\gamma_{Ms, C1}$	[-]	1,5						
Steel failure with threaded rod grade 12.9									
Characteristic resistance	$V_{Rk,s,C1}$	[kN]	15,4	24,5	35,7	65,8	102,9	148,4	235,2
Partial safety factor ¹⁾	$\gamma_{Ms, C1}$	[-]	1,5						
Steel failure with stainless steel threaded rod A4-70									
Characteristic resistance	$V_{Rk,s,C1}$	[kN]	9,1	14,4	20,7	38,5	59,9	86,5	137,4
Partial safety factor ¹⁾	$\gamma_{Ms, C1}$	[-]	1,56						
Steel failure with stainless steel threaded rod A4-80									
Characteristic resistance	$V_{Rk,s,C1}$	[kN]	10,2	16,1	23,5	44,1	68,6	98,7	157,2
Partial safety factor ¹⁾	$\gamma_{Ms, C1}$	[-]	1,33						
Steel failure with high corrosion stainless steel grade 70									
Characteristic resistance	$V_{Rk,s,C1}$	[kN]	9,1	14,4	20,7	38,5	59,9	86,5	137,4
Partial safety factor ¹⁾	$\gamma_{Ms, C1}$	[-]	1,56						

¹⁾ In the absence of other national regulation

Table C24: Characteristic resistance to shear loads – rebar under seismic performance category C1 – steel failure without lever arm

Size			Ø8	Ø10	Ø12	Ø14	Ø16	Ø20	Ø25	Ø32
Steel failure with rebar										
Characteristic resistance	$V_{Rk,s,C1}$	[kN]	$0,35 \cdot A_s^{2)} \cdot f_{uk}$							
Partial safety factor ¹⁾	$\gamma_{Ms, C1}$	[-]	1,5							

¹⁾ In the absence of other national regulation

²⁾ Stressed cross section of the steel element

R-KEX-II

Performances

Characteristic resistance to shear loads under seismic performance category C1

Annex C15
of European
Technical Assessment
ETA-21/0244

Table C25: Displacement under tension loads – threaded rod under seismic performance category C1

Size			M8	M10	M12	M16	M20	M24	M30
Displacement	$\delta_{N,C1}$	[mm]	2,8	3,0	3,0	3,2	3,3	4,0	5,5

Table C26: Displacement under shear loads – threaded rod under seismic performance category C1

Size			M8	M10	M12	M16	M20	M24	M30
Displacement	$\delta_{V,C1}$	[mm]	3,4	4,0	5,0	5,3	5,9	6,0	6,5

Table C27: Displacement under tension loads – rebar under seismic performance category C1

Size			Ø8	Ø10	Ø12	Ø14	Ø16	Ø20	Ø25	Ø32
Displacement	$\delta_{N,C1}$	[mm]	3,0	3,3	3,5	3,9	4,1	4,5	5,6	6,0

Table C28: Displacement under shear loads – rebar under seismic performance category C1

Size			Ø8	Ø10	Ø12	Ø14	Ø16	Ø20	Ø25	Ø32
Displacement	$\delta_{V,C1}$	[mm]	3,6	3,7	4,0	4,6	4,8	5,5	6,6	7,0

R-KEX-II

Performances

Displacement under service loads: tension and shear loads for seismic performance category C1 – threaded rod and rebar

Annex C16
of European
Technical Assessment
ETA-21/0244

Table C29: Characteristic resistance to tension load (threaded rod) – seismic performance category C2

Size			M12	M16	M20	M24
Steel failure						
Characteristic resistance	$N_{Rk,s,C2}$	[N/mm ²]	$N_{Rk,s}$	$N_{Rk,s}$	$N_{Rk,s}$	$N_{Rk,s}$
Combined pull-out and concrete cone failure (uncracked and cracked concrete)						
Characteristic bond resistance temperature range -40°C / +40°C	$\tau_{Rk,C2}$	[N/mm ²]	5,65	3,93	5,18	3,65
Characteristic bond resistance temperature range -40°C / +80°C	$\tau_{Rk,C2}$	[N/mm ²]	5,03	3,50	4,61	3,25

Table C30: Characteristic resistance to shear load (threaded rod) – seismic performance category C2

Size			M12	M16	M20	M24
Steel failure with threaded rod grade 5.8						
Characteristic resistance	$V_{Rk,s,C2}$	[N/mm ²]	11,6	13,7	26,3	47,0
Steel failure with threaded rod grade 8.8						
Characteristic resistance	$V_{Rk,s,C2}$	[N/mm ²]	18,5	22,0	42,1	75,1
Steel failure with threaded rod grade 10.9						
Characteristic resistance	$V_{Rk,s,C2}$	[N/mm ²]	23,2	27,4	52,6	93,9
Steel failure with threaded rod grade 12.9						
Characteristic resistance	$V_{Rk,s,C2}$	[N/mm ²]	27,8	32,9	63,2	112,6
Stainless steel, property class A4-70						
Characteristic resistance	$V_{Rk,s,C2}$	[N/mm ²]	15,8	19,2	36,9	66,0
Stainless steel, property class A4-80						
Characteristic resistance	$V_{Rk,s,C2}$	[N/mm ²]	18,5	22,0	42,1	75,1
High corrosion resistant stainless steel, property class 70						
Characteristic resistance	$V_{Rk,s,C2}$	[N/mm ²]	15,8	19,2	36,9	66,0

Table C31: Displacements under tensile and shear load (threaded rod) – seismic performance category C2

Size			M12	M16	M20	M24
Displacements for tensile and shear load for seismic performance category C2						
Displacement in tensile at damage limitation states ¹⁾	$\delta_{N,eq,C2} (DLS)$	[mm]	0,85	1,14	0,77	0,94
Displacement in tensile at ultimate limit state ¹⁾	$\delta_{N,eq,C2} (ULS)$	[mm]	1,70	2,01	2,07	1,91
Displacement in shear at damage limitation states ¹⁾	$\delta_{V,eq,C2} (DLS)$	[mm]	3,01	2,28	3,60	3,15
Displacement in shear at ultimate limit state ¹⁾	$\delta_{V,eq,C2} (ULS)$	[mm]	6,44	8,81	7,57	8,21

¹⁾ All temperature ranges

R-KEX-II

Performances

Characteristic resistance to tension and shear loads – threaded rod under seismic performance category C2

Annex C17
of European
Technical Assessment
ETA-21/0244